

MAVERICK
OFFICE SOLUTIONS | MADE IN THE U.S.A

quick

ship

PRICE LIST
August 1, 2021/2022

Maverick Series 2-16

- Configurations 3-4
- Desks 5-7

Bridges and Returns 8-9

- Credenzas 9-12
- Hutches 12

Bookcases, Storage and Files 13

Upgrades and Accessories 14-16

contents

Maverick Complete 17-38

- Configurations 18-19
- Desks 20-25
- Bridges and Returns 26-28
- Credenzas 29-34
- Hutches 35

Bookcases, Storage and Files 36

Upgrades and Accessories 37-38

Conference and Training 39-47

Color Options 48

Place your order by NOON and ID as “Quick Ship” on the purchase order

maverick series



If you need something fast within our Quick Ship program, the Maverick Series and Maverick Complete has over 500 SKUs that you can get in ⚡ 3 days. From complete desk set-ups, to filing, to conferencing, we've got you covered. You can mix and match two colors between all 20 of our color options, to create a customized office with no change in lead time.

Our Quick Ship program is why we're called: "The Fastest Desk in the West".



maverick series

Configurations

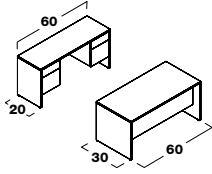

☞ MM1		
1 MMD3060	\$1,192	
1 MMC2060 3	\$1,177	
	\$2,369	

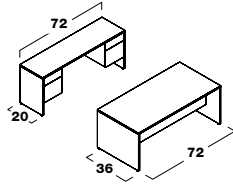

☞ MM2		
1 MMD3672	\$1,486	
1 MMC2072 3	\$1,446	
	\$2,932	

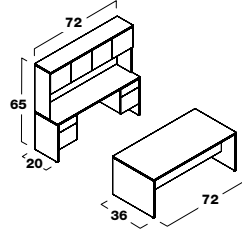

☞ MM3		
1 MMD3672	\$1,486	
1 MMC2072 3	\$1,446	
1 MMH72WD	\$1,418	
	\$4,350	

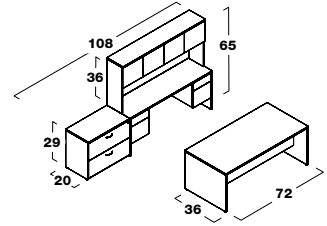

☞ MM4		
1 MMD3672	\$1,486	
1 MMC2072 3	\$1,446	
1 MMH72WD	\$1,418	
1 MMLF202	\$1,080	
	\$5,430	

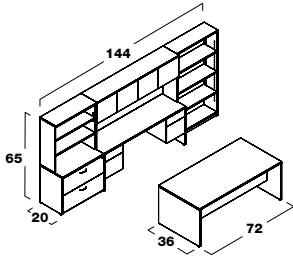

☞ MM5		
1 MMD3672	\$1,486	
1 MMC2072 3	\$1,446	
1 MMH72WD	\$1,418	
1 MMLF202	\$1,080	
1 MMBCH	\$520	
1 MMBC3665	\$848	
	\$6,798	

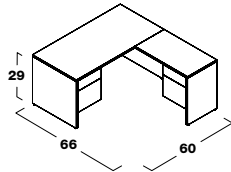

☞ MM6R		
1 MMS3060L	\$992	
1 MMRA2036R	\$821	
	\$1,813	

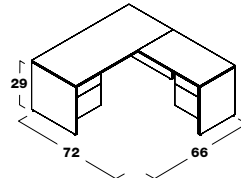

☞ MM7R		
1 MMS3066L	\$1,114	
1 MMRA2442R	\$970	
	\$2,084	

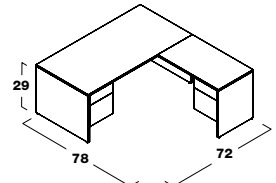

☞ MM8R		
1 MMS3672L	\$1,192	
1 MMRA2442R	\$970	
	\$2,162	

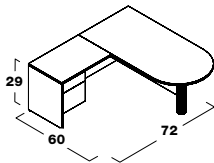

☞ MM9L		
1 MMBD3060L	\$941	
1 MMRA2042L	\$837	
	\$1,778	

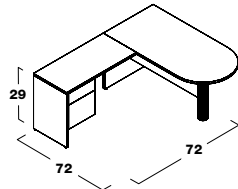

☞ MM10L		
1 MMBD3672L	\$1,149	
1 MMRA2436L	\$936	
	\$2,085	

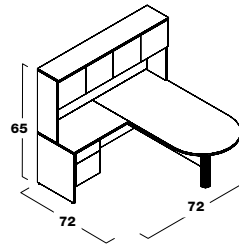

☞ MM11L		
1 MMBD3672L	\$1,149	
1 MMRA2436L	\$936	
1 MMH72WD	\$1,418	
	\$3,503	

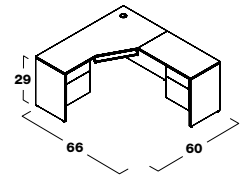

☞ MM12R		
1 MMCD60 2L	\$1,177	
1 MMRA2036R	\$821	
	\$1,998	

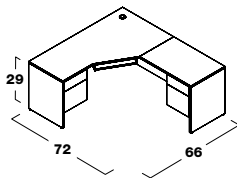

☞ MM13R		
1 MMCD66 4L	\$1,289	
1 MMRA2436R	\$936	
	\$2,225	

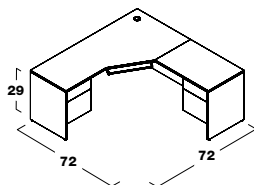

☞ MM14R		
1 MMCD72 4L	\$1,230	
1 MMRA2436R	\$936	
	\$2,166	

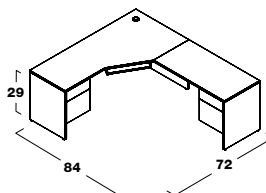

☞ MM15R		
1 MMCD72 4L	\$1,230	
1 MMRA2448R	\$987	
	\$2,217	

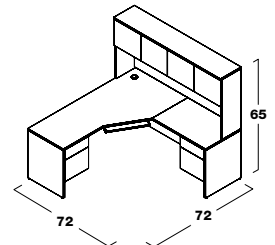

☞ MM16R		
1 MMCD72 4L	\$1,230	
1 MMRA2436R	\$936	
1 MMH72WD	\$1,418	
	\$3,584	

maverick series

Configurations

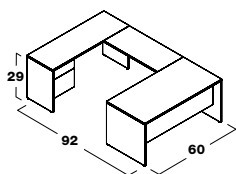

☞ MM17L	
1 MMS3060R	\$992
1 MMBR2042	\$305
1 MMC2060 4L	\$961
\$2,258	

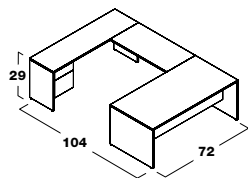

☞ MM18L	
1 MMS3672R	\$1,192
1 MMBR2448	\$461
1 MMC2072 4L	\$1,101
\$2,754	

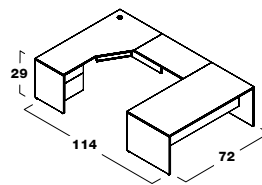

☞ MM19L	
1 MMS3672R	\$1,192
1 MMBR2442	\$411
1 MMCD72 4L	\$1,230
\$2,833	

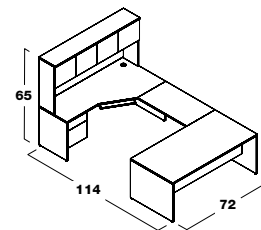

☞ MM20L	
1 MMS3672R	\$1,192
1 MMBR2442	\$411
1 MMCD72 4L	\$1,230
1 MMH72WD	\$1,418
\$4,251	

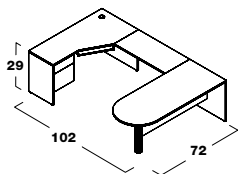

☞ MM21L	
1 MMBD3072L	\$1,080
1 MMBR2042	\$305
1 MMCD60 2L	\$1,177
\$2,562	

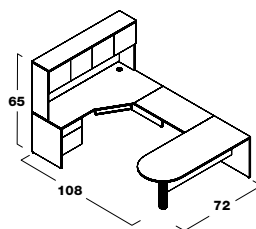

☞ MM22L	
1 MMBD3072L	\$1,080
1 MMBR2442	\$411
1 MMCD72 4L	\$1,230
1 MMH72WD	\$1,418
\$4,139	

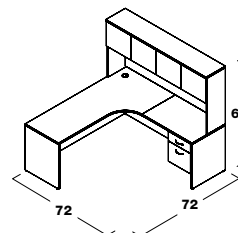

☞ MM26R	
1 MMCDNQ72 4R FMP	\$1,175
1 MMRA2436R, H3B	\$1,000
1 MMH72WD	\$1,418
\$3,593	

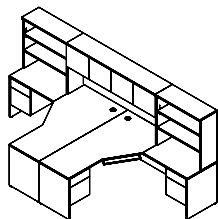

☞ MM28	
1 MMCD72 4R	\$1,230
1 MMCD72 4L	\$1,230
1 MMRA2436R	\$936
1 MMRA2436L	\$936
2 MMBCH	\$1,040
1 MMH72WD	\$1,418
\$6,790	

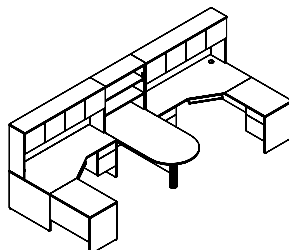

☞ MM29	
1 MMCD72 4R	\$1,230
1 MMCD72 4L	\$1,230
1 MMRA2436R	\$936
1 MMRA2436L	\$936
1 MMBD3672L	\$1,149
2 MMH72WD	\$2,836
1 MMBCH	\$520
\$8,837	

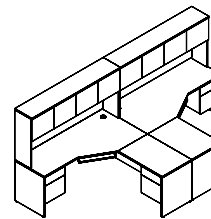

☞ MM30	
1 MMCD72 4R	\$1,230
1 MMCD72 4L	\$1,230
1 MMRA2436R	\$936
1 MMRA2436L	\$936
2 MMH72WD	\$2,836
\$7,168	

NOTE: BULLET DESK STAND ALONE w/ POST LEG WHEN ORDER AS MM29 CONFIGURATION, MUST SPECIFY.

maverick series

Desks

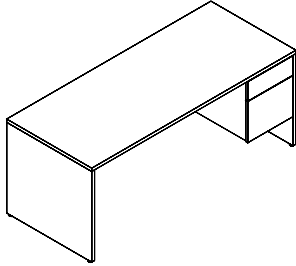

Single Pedestal Desk, Box/File Right (¾ Modesty)

Model#	Depth	Width	Height	Weight	Cube	Price
☞ MMS2042R	20"	42"	29"	120	15	\$907
☞ MMS2060R	20"	60"	29"	150	20	\$978
☞ MMS2066R	20"	66"	29"	156	23	\$1,101
☞ MMS2072R	20"	72"	29"	163	24	\$1,114
☞ MMS2442R	24"	42"	29"	127	18	\$941
☞ MMS2448R	24"	48"	29"	130	20	\$960
☞ MMS3048R	30"	48"	29"	142	25	\$976
☞ MMS3060R	30"	60"	29"	190	32	\$992
☞ MMS3066R	30"	66"	29"	197	35	\$1,114
☞ MMS3072R	30"	72"	29"	210	38	\$1,133
☞ MMS3672R	36"	72"	29"	225	45	\$1,192

For handles and pedestal lock, add MMUHL2...\$78 (Specify H3B-H10B & H14, see p. 14).
For full modesty panel upgrade, add MMFMP...\$74.

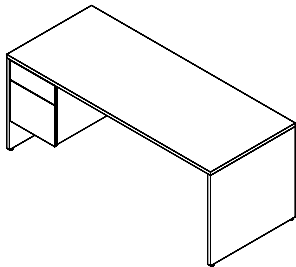

Single Pedestal Desk, Box/File Left (¾ Modesty)

Model#	Depth	Width	Height	Weight	Cube	Price
☞ MMS2042L	20"	42"	29"	120	15	\$907
☞ MMS2060L	20"	60"	29"	150	20	\$978
☞ MMS2066L	20"	66"	29"	156	23	\$1,101
☞ MMS2072L	20"	72"	29"	163	24	\$1,114
☞ MMS2442L	24"	42"	29"	127	18	\$941
☞ MMS2448L	24"	48"	29"	130	20	\$960
☞ MMS3048L	30"	48"	29"	142	25	\$976
☞ MMS3060L	30"	60"	29"	190	32	\$992
☞ MMS3066L	30"	66"	29"	197	35	\$1,114
☞ MMS3072L	30"	72"	29"	210	38	\$1,133
☞ MMS3672L	36"	72"	29"	225	45	\$1,192

For handles and pedestal lock, add MMUHL2...\$78 (Specify H3B-H10B & H14, see p. 14).
For full modesty panel upgrade, add MMFMP...\$74.

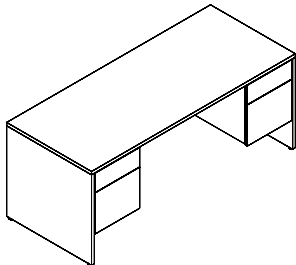

Double Pedestal Desk, Box/File Left and Right (¾ Modesty)

Model#	Depth	Width	Height	Weight	Cube	Price
☞ MMD3060	30"	60"	29"	260	32	\$1,192
☞ MMD3066	30"	66"	29"	266	35	\$1,445
☞ MMD3072	30"	72"	29"	270	38	\$1,469
☞ MMD3672	36"	72"	29"	276	45	\$1,486

For handles and pedestal lock, add MMUHL2...\$78 each (Specify H3B-H10B & H14, see p. 14).
For full modesty panel upgrade, add MMFMP...\$74.

See available accessories and upgrades, pp. 14-16.
Note: 60"W Single Pedestal Desks are recommended with 20"D Returns only.

maverick series

Desks

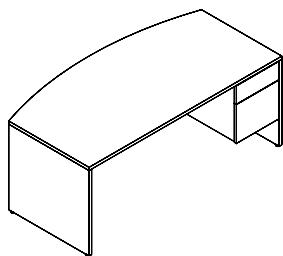

Fan Top Single Pedestal Desk, Box/File Right (¾ inset Modesty)

Model#	Depth	Width	Height	Weight	Cube	Price
☞ MMFS3672R	30-36"	72"	29"	233	45	\$1,469
☞ MMFS4272R	36-42"	72"	29"	258	53	\$1,521

For handles and pedestal lock, add MMUHL2...\$78 each (Specify H3B-H10 & H14, see p. 14).
For full modesty panel upgrade, add MMFMP...\$74.

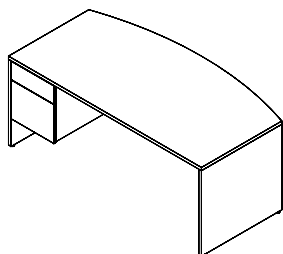

Fan Top Single Pedestal Desk, Box/File Left (¾ Modesty)

Model#	Depth	Width	Height	Weight	Cube	Price
☞ MMFS3672L	30-36"	72"	29"	233	45	\$1,469
☞ MMFS4272L	36-42"	72"	29"	258	53	\$1,521

For handles and pedestal lock, add MMUHL2...\$78 each (Specify H3B-H10 & H14, see p. 14).
For full modesty panel upgrade, add MMFMP...\$74.

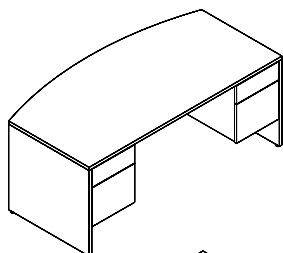

Double Pedestal Desk, Box/File Left and Right (¾ Modesty)

Model#	Depth	Width	Height	Weight	Cube	Price
☞ MMFD3672	30-36"	72"	29"	280	45	\$1,792
☞ MMFD4272	36-42"	72"	29"	305	53	\$1,808

For handles and pedestal lock, add MMUHL2...\$78 each (Specify H3B-H10 & H14, see p. 14).
For full modesty panel upgrade, add MMFMP...\$74.

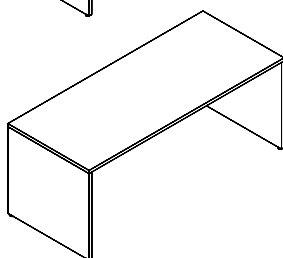

Desk Shell ¾ Modesty (Flush modesty)

Model#	Depth	Width	Height	Weight	Cube	Price
☞ MMN2042	20"	42"	29"	84	17	\$536
☞ MMN2048	20"	48"	29"	84	17	\$552
☞ MMN2060	20"	60"	29"	92	20	\$598
☞ MMN2066	20"	66"	29"	96	23	\$640
☞ MMN2072	20"	72"	29"	100	24	\$657
☞ MMN2436	24"	36"	29"	89	16	\$544
☞ MMN2442	24"	42"	29"	95	18	\$598
☞ MMN2448	24"	48"	29"	104	20	\$613
☞ MMN2460	24"	60"	29"	120	25	\$657
☞ MMN2466	24"	66"	29"	127	28	\$744
☞ MMN2472	24"	72"	29"	132	30	\$796

For left or right ½ leg specify on order...N/C. For full modesty panel upgrade, add MMFMP...\$74.

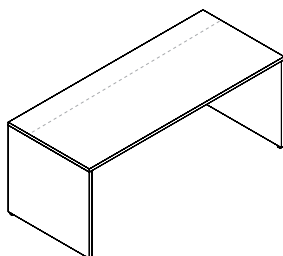

Desk Shell ¾ Modesty, Inset Modesty (30"D-6" Inset modesty, 36"D-12" Inset modesty)

Model#	Depth	Width	Height	Weight	Cube	Price
☞ MMN3042	30"	42"	29"	114	22	\$657
☞ MMN3048	30"	48"	29"	120	25	\$676
☞ MMN3060	30"	60"	29"	126	32	\$693
☞ MMN3066	30"	66"	29"	132	35	\$772
☞ MMN3072	30"	72"	29"	138	38	\$796
☞ MMN3672	36"	72"	29"	152	45	\$813

For left or right ½ leg specify on order...N/C. For full modesty panel upgrade, add MMFMP...\$74.

See available accessories and upgrades, pp. 14-16.

maverick series

Desks

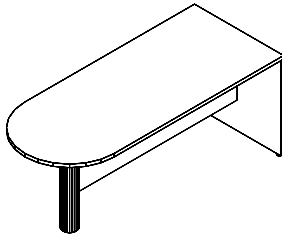

Bullet Desk, (¾ Modesty, 4" black post) For Right Return

Model#	Depth	Width	Height	Weight	Cube	Price
☞ MMBD3060R	30"	60"	29"	180	32	\$941
☞ MMBD3072R	30"	72"	29"	195	35	\$1,080
☞ MMBD3660R	36"	60"	29"	185	38	\$1,080
☞ MMBD3672R	36"	72"	29"	205	45	\$1,149

For silver post upgrade, add MMUHLEGJS...\$34. For full modesty panel upgrade, add MMFMP...\$74. Must specify if using left and right connection or stand alone. N/C.

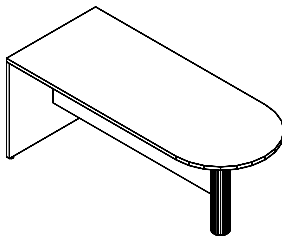

Bullet Desk, (¾ modesty, 4" black post) For Left Return

Model#	Depth	Width	Height	Weight	Cube	Price
☞ MMBD3060L	30"	60"	29"	180	32	\$941
☞ MMBD3072L	30"	72"	29"	195	35	\$1,080
☞ MMBD3660L	36"	60"	29"	185	38	\$1,080
☞ MMBD3672L	36"	72"	29"	205	45	\$1,149

For silver post upgrade, add MMUHLEGJS...\$34. For full modesty panel upgrade, add MMFMP...\$74. Must specify if using left and right connection or stand alone. N/C

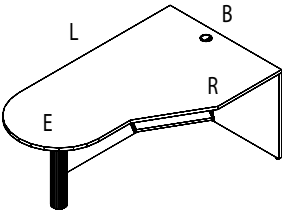

Bullet Computer Desk (¾ Modesty, 4" black post) For Right Return

Model#	Depth (B,E)	Width (L,R)	Height	Weight	Cube	Price
☞ MMBDC427230R	42/30"	72"/24"	29"	195	53	\$1,230
☞ MMBDC427830R	42/30"	78"/24"	29"	205	58	\$1,505

Keyboard tray and worksurface black grommet are standard. Upgrade grommet cover to silver, N/C. For silver post upgrade, add MMUHLEGJS...\$34. For full modesty panel upgrade, add MMFMP...\$74.

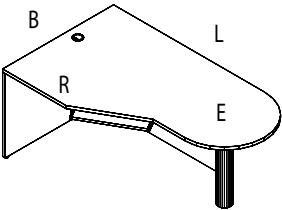

Bullet Computer Desk (¾ Modesty, 4" black post) For Left Return

Model#	Depth (B,E)	Width (L,R)	Height	Weight	Cube	Price
☞ MMBDC427230L	42/30"	72"/24"	29"	195	53	\$1,230
☞ MMBDC427830L	42/30"	78"/24"	29"	205	58	\$1,505

Keyboard tray and worksurface black grommet are standard. Upgrade grommet cover to silver, N/C. For silver post upgrade, add MMUHLEGJS...\$34. For full modesty panel upgrade, add MMFMP...\$74.

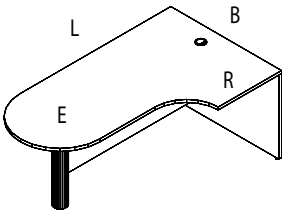

Bullet Computer Desk, Curved (¾ Modesty, 4" black post) For Right Return

Model#	Depth (B,E)	Width (L,R)	Height	Weight	Cube	Price
☞ MMBDCQ427230R	42/30"	72"/24"	29"	195	53	\$1,230

Worksurface black grommet standard. Upgrade grommet cover to silver, N/C. For silver post upgrade, add MMUHLEGJS...\$34. For full modesty panel upgrade, add MMFMP...\$74.

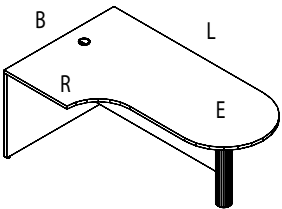

Bullet Computer Desk, Curved (¾ Modesty, 4" black post) For Left Return

Model#	Depth (B,E)	Width (L,R)	Height	Weight	Cube	Price
☞ MMBDCQ427230L	42/30"	72"/24"	29"	195	53	\$1,230

Worksurface black grommet standard. Upgrade grommet cover to silver, N/C. For silver post upgrade, add MMUHLEGJS...\$34. For full modesty panel upgrade, add MMFMP...\$74.

**NOTE: All bullet desks & computer desks, specify if standalone.
Standalone is made with ½ leg (MMSPT) at no charge, replaces post leg.**

maverick series

Bridges

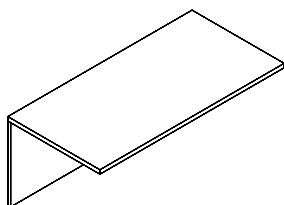

Bridge Section (¾ Modesty)

Model#	Depth	Width	Height	Weight	Cube	Price
☞ MMBR2036	20"	36"	29"	41	9	\$286
☞ MMBR2042	20"	42"	29"	48	10	\$305
☞ MMBR2048	20"	48"	29"	55	12	\$358
☞ MMBR2436	24"	36"	29"	47	10	\$324
☞ MMBR2442	24"	42"	29"	55	12	\$411
☞ MMBR2448	24"	48"	29"	63	14	\$461
☞ MMBR2460	24"	60"	29"	78	15	\$560

¾ modesty standard. ½ modesty on bridges may be specified at no upcharge.
 For full modesty panel upgrade, add MMFMP...\$74.
 60"W bridge requires ½ leg center support, add MMSPT \$130 list.

Returns

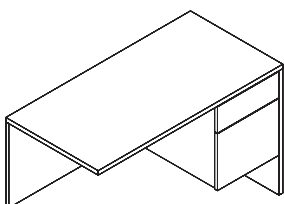

Return, ¾ Box/File Pedestal Right (¾ Modesty)

Model#	Depth	Width	Height	Weight	Cube	Price
☞ MMRA2036R	20"	36"	29"	95	13	\$821
☞ MMRA2042R	20"	42"	29"	104	15	\$837
☞ MMRA2048R	20"	48"	29"	110	17	\$856
☞ MMRA2054R	20"	54"	29"	117	19	\$889
☞ MMRA2436R	24"	36"	29"	100	15	\$936
☞ MMRA2442R	24"	42"	29"	107	18	\$970
☞ MMRA2448R	24"	48"	29"	114	20	\$987
☞ MMRA2454R	24"	54"	29"	121	23	\$1,056
☞ MMRA2460R	24"	60"	29"	124	24	\$1,074
☞ MMRA3048R	30"	48"	29"	127	25	\$1,074

¾ modesty standard. ½ modesty on returns may be specified at no upcharge.
 For handles and pedestal lock, add MMUHL2...\$78 (Specify H3B-H10B & H14, see p. 14).
 For full modesty panel upgrade, add MMFMP...\$74.

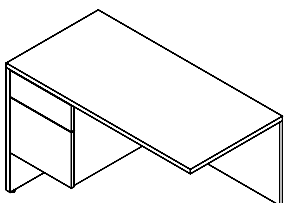

Return, ¾ Box/File Pedestal Left (¾ Modesty)

Model#	Depth	Width	Height	Weight	Cube	Price
☞ MMRA2036L	20"	36"	29"	95	13	\$821
☞ MMRA2042L	20"	42"	29"	104	15	\$837
☞ MMRA2048L	20"	48"	29"	110	17	\$856
☞ MMRA2054L	20"	54"	29"	117	19	\$889
☞ MMRA2436L	24"	36"	29"	100	15	\$936
☞ MMRA2442L	24"	42"	29"	107	18	\$970
☞ MMRA2448L	24"	48"	29"	114	20	\$987
☞ MMRA2454L	24"	54"	29"	121	23	\$1,056
☞ MMRA2460L	24"	60"	29"	124	24	\$1,074
☞ MMRA3048L	30"	48"	29"	127	25	\$1,074

¾ modesty standard. ½ modesty on returns may be specified at no upcharge.
 For handles and pedestal lock, add MMUHL2...\$78 (Specify H3B-H10B & H14, see p. 14).
 For full modesty panel upgrade, add MMFMP...\$74.

NOTE: If placing hutch on return, ½ leg support is required, add MMSPT \$130.

maverick series

Returns

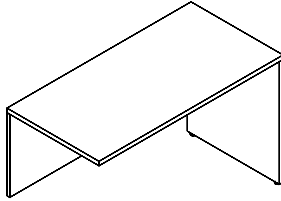

Return Shell Right (¾ Modesty)

Model#	Depth	Width	Height	Weight	Cube	Price
☞ MMRN2036R	20"	36"	29"	60	13	\$411
☞ MMRN2042R	20"	42"	29"	67	15	\$428
☞ MMRN2048R	20"	48"	29"	73	17	\$487
☞ MMRN2054R	20"	54"	29"	80	19	\$542
☞ MMRN2436R	24"	36"	29"	56	15	\$551
☞ MMRN2442R	24"	42"	29"	67	18	\$584
☞ MMRN2448R	24"	48"	29"	74	20	\$622
☞ MMRN2454R	24"	54"	29"	80	23	\$662
☞ MMRN3048R	30"	48"	29"	89	25	\$715

¾ modesty standard. ½ modesty on returns may be specified at no upcharge.
For full modesty panel upgrade, add MMFMP...\$74.

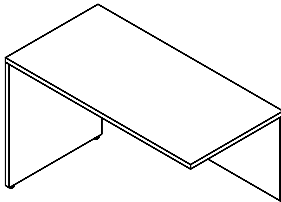

Return Shell Left (¾ Modesty)

Model#	Depth	Width	Height	Weight	Cube	Price
☞ MMRN2036L	20"	36"	29"	60	13	\$411
☞ MMRN2042L	20"	42"	29"	67	15	\$428
☞ MMRN2048L	20"	48"	29"	73	17	\$487
☞ MMRN2054L	20"	54"	29"	80	19	\$542
☞ MMRN2436L	24"	36"	29"	56	15	\$551
☞ MMRN2442L	24"	42"	29"	67	18	\$584
☞ MMRN2448L	24"	48"	29"	74	20	\$622
☞ MMRN2454L	24"	54"	29"	80	23	\$662
☞ MMRN3048L	30"	48"	29"	89	25	\$715

¾ modesty standard. ½ modesty on returns may be specified at no upcharge.
For full modesty panel upgrade, add MMFMP...\$74.

NOTE: If placing hutch on return, ½ leg support is required, add MMSPT \$130.

Credenzas

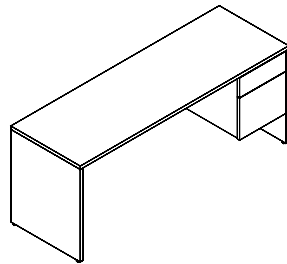

Credenza, Single Box/File Pedestal Right (¾ Modesty)

Model#	Depth	Width	Height	Weight	Cube	Price
☞ MMC2060 4R	20"	60"	29"	150	21	\$961
☞ MMC2066 4R	20"	66"	29"	157	23	\$1,080
☞ MMC2072 4R	20"	72"	29"	164	25	\$1,101
☞ MMC2472 4R	24"	72"	29"	168	30	\$1,133

For full modesty panel upgrade, add MMFMP...\$74.
For handles and pedestal lock, add MMUHL2...\$78 (Specify H3B-H10B & H14, see p. 14).

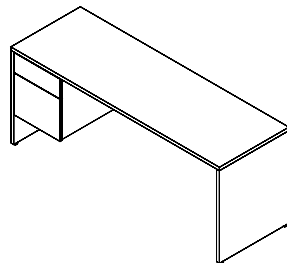

Credenza, Single Box/File Pedestal Left (¾ Modesty)

Model#	Depth	Width	Height	Weight	Cube	Price
☞ MMC2060 4L	20"	60"	29"	150	21	\$961
☞ MMC2066 4L	20"	66"	29"	157	23	\$1,080
☞ MMC2072 4L	20"	72"	29"	164	25	\$1,101
☞ MMC2472 4L	24"	72"	29"	168	30	\$1,133

For full modesty panel upgrade, add MMFMP...\$74.
For handles and pedestal lock, add MMUHL2...\$78 (Specify H3B-H10B & H14, see p. 14).

See available accessories and upgrades, pp. 14-16.

maverick series

CompuCorner Credenzas

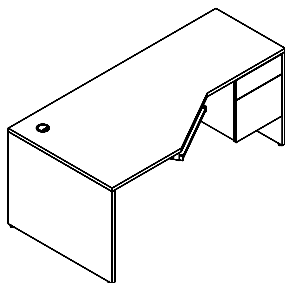

Computer Corner, Box/File Pedestal Right (¾ Modesty)

Model#	(L)	(B)	(E)	(K)	(R)	(W)	Weight	Cube	Price
☞ MMCD60 2R	60"	30"	20"	21"	20"	21"	220	32	\$1,177
☞ MMCD60 4R	60"	36"	24"	21"	24"	22"	220	32	\$1,193
☞ MMCD66 4R	66"	36"	24"	21"	24"	24"	229	42	\$1,289
☞ MMCD72 3R	72"	36"	20"	24"	20"	33"	249	45	\$1,369
☞ MMCD72 4R	72"	36"	24"	21"	24"	30"	249	45	\$1,230
☞ MMCD72 7R	72"	36"	24"	23"	20"	32"	285	45	\$1,348
☞ MMCD72 8R	72"	42"	24"	24"	24"	33"	285	53	\$1,652

For full modesty panel upgrade, add MMFMP...\$74. Keyboard tray and worksurface black grommet standard. Upgrade grommet cover to silver, N/C. For handles and pedestal lock, add MMUHL2...\$78 (Specify H3B-H10B & H14, see p. 14).

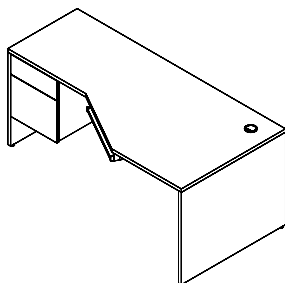

Computer Corner, Box/File Pedestal Left (¾ Modesty)

Model#	(L)	(B)	(E)	(K)	(R)	(W)	Weight	Cube	Price
☞ MMCD60 2L	60"	30"	20"	21"	20"	21"	220	32	\$1,177
☞ MMCD60 4L	60"	36"	24"	21"	24"	22"	220	32	\$1,193
☞ MMCD66 4L	66"	36"	24"	21"	24"	24"	229	42	\$1,289
☞ MMCD72 3L	72"	36"	20"	24"	20"	33"	249	45	\$1,369
☞ MMCD72 4L	72"	36"	24"	21"	24"	30"	249	45	\$1,230
☞ MMCD72 7L	72"	36"	24"	23"	20"	32"	285	45	\$1,348
☞ MMCD72 8L	72"	42"	24"	24"	24"	33"	285	53	\$1,652

For full modesty panel upgrade, add MMFMP...\$74. Keyboard tray and worksurface black grommet standard. Upgrade grommet cover to silver, N/C. For handles and pedestal lock, add MMUHL2...\$78 (Specify H3B-H10B& H14, see p. 14).

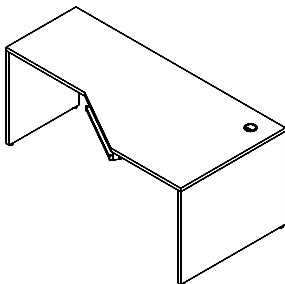

Computer Corner Shell (¾ Modesty) For Right Return

Model#	(L)	(B)	(E)	(K)	(R)	(W)	Weight	Cube	Price
☞ MMCDN60 2R	60"	30"	20"	21"	20"	21"	184	32	\$907
☞ MMCDN72 3R	72"	36"	20"	24"	20"	33"	213	45	\$1,063
☞ MMCDN72 4R	72"	36"	24"	21"	24"	30"	213	45	\$1,101

Keyboard tray and worksurface black grommet standard. Upgrade grommet cover to silver, N/C. For full modesty panel upgrade, add MMFMP...\$74.

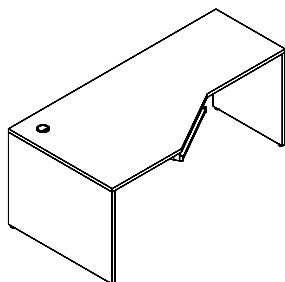

Computer Corner Shell (¾ Modesty) For Left Return

Model#	(L)	(B)	(E)	(K)	(R)	(W)	Weight	Cube	Price
☞ MMCDN60 2L	60"	30"	20"	21"	20"	21"	184	32	\$907
☞ MMCDN72 3L	72"	36"	20"	24"	20"	33"	213	45	\$1,063
☞ MMCDN72 4L	72"	36"	24"	21"	24"	30"	213	45	\$1,101

Keyboard tray and worksurface black grommet standard. Upgrade grommet cover to silver, N/C. For full modesty panel upgrade, add MMFMP...\$74.

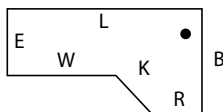

- "L" Length along approach edge
- "B" Back end panel
- "E" End panel
- "K" Keyboard space
- "R" Return depth to attach
- "W" Workarea (kbrd to end)

maverick series

CompuCorner Credenzas

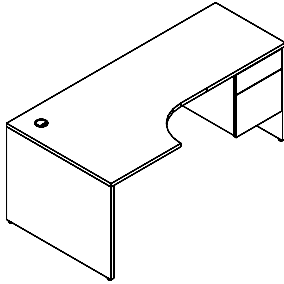

Computer Corner, Curved, 3/4 Box/File Pedestal Right (3/4 Modesty)

Model#	(L)	(B)	(E)	(K)	(R)	(W)	Weight	Cube	Price
MMCDQ72 4R	72"	36"	24"	21"	24"	30"	239	45	\$1,230

No keyboard tray. Worksurface black grommet standard. Upgrade grommet cover to silver, N/C.
 For handles and pedestal lock, add MMUHL2...\$78. (Specify H3B-H10B & H14, see p. 14).
 For full modesty panel upgrade, add MMFMP..\$74.

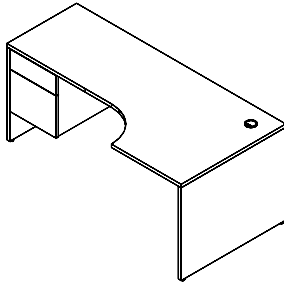

Computer Corner, Curved, 3/4 Box/File Pedestal Left (3/4 Modesty)

Model#	(L)	(B)	(E)	(K)	(R)	(W)	Weight	Cube	Price
MMCDQ72 4L	72"	36"	24"	21"	24"	30"	239	45	\$1,230

No keyboard tray. Worksurface black grommet standard. Upgrade grommet cover to silver, N/C.
 For handles and pedestal lock, add MMUHL2...\$78. (Specify H3B-H10B & H14, see p. 14).
 For full modesty panel upgrade, add MMFMP..\$74.

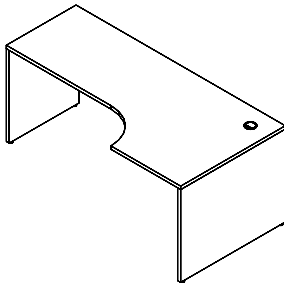

Computer Corner Shell, Curved (3/4 Modesty) For Right Return

Model#	(L)	(B)	(E)	(K)	(R)	(W)	Weight	Cube	Price
MMCDNQ72 4R	72"	36"	24"	21"	24"	30"	213	45	\$1,101

Worksurface black grommet standard. No keyboard tray. Upgrade grommet cover to silver, N/C.
 For full modesty panel upgrade, add MMFMP..\$74.

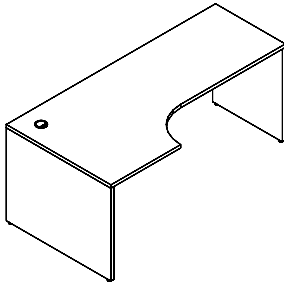

Computer Corner Shell, Curved (3/4 Modesty) For Left Return

Model#	(L)	(B)	(E)	(K)	(R)	(W)	Weight	Cube	Price
MMCDNQ72 4L	72"	36"	24"	21"	24"	30"	213	45	\$1,101

Worksurface black grommet standard. No keyboard tray. Upgrade grommet cover to silver, N/C.
 For full modesty panel upgrade, add MMFMP..\$74.

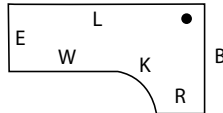

- "L" Length along approach edge
- "B" Back end panel
- "E" End panel
- "K" Keyboard space
- "R" Return depth to attach
- "W" Workarea (kbd to end)

maverick series

Credenzas

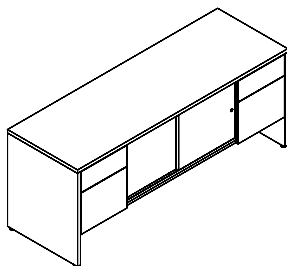

Credenza Double Pedestal, Box/File Left and Right, Center Storage (Sliding doors, ¾ modesty)

Model#	Depth	Width	Height	Weight	Cube	Price
☞ MMC2060 2	20"	60"	29"	230	21	\$1,270
☞ MMC2066 2	20"	66"	29"	240	23	\$1,505
☞ MMC2072 2	20"	72"	29"	250	25	\$1,521
☞ MMC2472 2	24"	72"	29"	270	30	\$1,617

Storage includes 1 adjustable ¾"-thick shelf.
For handles and pedestal lock, add MMUHL2...\$78 each pedestal (Specify H3B-H10B & H14, see p. 14).
NOTE: Ped lock is inside doors.

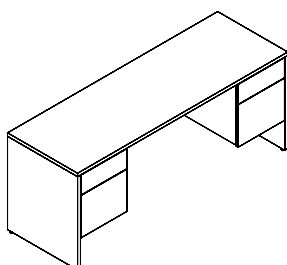

Credenza Double Pedestal, Box/File Left and Right (Knee space, ¾ modesty)

Model#	Depth	Width	Height	Weight	Cube	Price
☞ MMC2060 3	20"	60"	29"	196	21	\$1,177
☞ MMC2066 3	20"	66"	29"	205	23	\$1,418
☞ MMC2072 3	20"	72"	29"	210	25	\$1,446
☞ MMC2472 3	24"	72"	29"	230	30	\$1,486

For full modesty panel upgrade, add MMFMP...\$74.
For handles and pedestal lock, add MMUHL2...\$78 each pedestal (Specify H3B-H10B & H14, see p. 14).

Hutches

(Maverick Series hutch fits Maverick Series worksurfaces only)

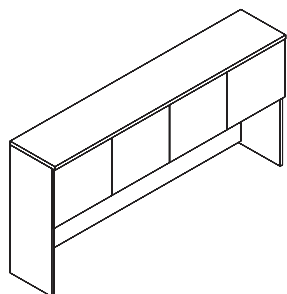

Hutch, with Four Hinged Doors (19" clearance below doors)

Model#	Depth	Width	Height	Weight	Cube	Price
☞ MMH48WD	14"	48"	36"	130	14	\$1,177
☞ MMH60WD	14"	60"	36"	155	18	\$1,270
☞ MMH66WD	14"	66"	36"	167	20	\$1,383
☞ MMH72WD	14"	72"	36"	179	21	\$1,418

Optional face locks (2 locks required), add MMFL...\$90 each.
Ends are ¾" thick; doors overlay legs but are inset to the 1"-thick top. ¾" back panel cord gap.
35lb. weight capacity distributed evenly.

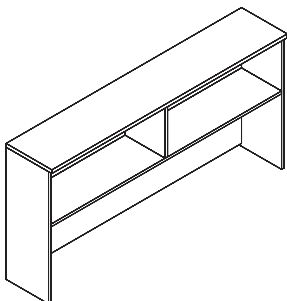

Hutch, No Doors (20" clearance below shelf)

Model#	Depth	Width	Height	Weight	Cube	Price
☞ MMH48ND	14"	48"	36"	115	14	\$848
☞ MMH60ND	14"	60"	36"	135	18	\$881
☞ MMH66ND	14"	66"	36"	148	20	\$960
☞ MMH72ND	14"	72"	36"	160	21	\$1,063

Ends are ¾" thick; doors overlay legs but are inset to the 1"-thick top. ¾" back panel cord gap.
35lb. weight capacity distributed evenly.

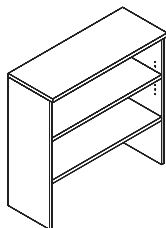

Bookcase Hutch, Full Back Panel
(One adjustable shelf, one fixed shelf, 1"-thick shelves) Bottom clearance 12"H

Model#	Depth	Width	Height	# Shelves	Weight	Cube	Price
☞ MMBCH	14"	36"	36"	2	72	11	\$520

Ends are ¾" thick; legs are inset to the 1"-thick top. Width coordinates w/ lateral files and utility cabinets.
35lb. weight capacity distributed evenly.

NOTE: If hutch is placed on L-unit return ½ leg support is required, add MMSPT \$130.

See available accessories and upgrades, pp. 14-16.

maverick series

Bookcase

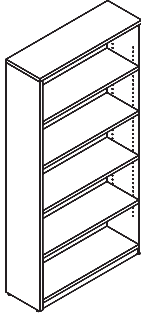

Bookcase (1"-thick adjustable shelves)

Model#	Depth	Width	Height	# Shelves	Weight	Cube	Price
MMBC3630	12"	36"	29"	1	61	18	\$502
MMBC3648	12"	36"	48"	2	86	12	\$676
MMBC3660	12"	36"	60"	3	107	15	\$813
MMBC3665	12"	36"	65"	3	111	17	\$848
MMBC3672	12"	36"	72"	4	128	18	\$881
MMBC3684	12"	36"	84"	5	137	21	\$1,101

For additional adjustable shelf, add MMSH1 \$130 ea. Includes 4-pins per shelf.

Storage

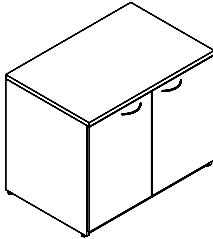

Hinged Door Utility Cabinet (H3B handle, one ¾"-thick adjustable shelf)

Model#	Depth	Width	Height	Weight	Cube	Price
MMHDC2036	20"	36"	29"	115	13	\$907
MMHDC2436	24"	36"	29"	175	15	\$1,047

Optional lock available, add MMFL...\$90. Width coordinates with bookcase hutch.
Upgrade to H3S handles...N/C.

Files

(All drawers depth are 16"D except vertical files)

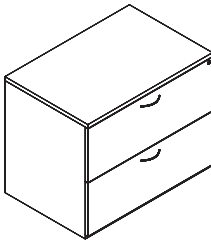

2-drawer Lateral File (H3B handles, lock)

Model#	Depth	Width	Height	Weight	Cube	Price
MMLF202	20"	36"	29"	135	11	\$1,080
MMLF242	24"	36"	29"	147	13	\$1,133

Upgrade to H3S Handle N/C.

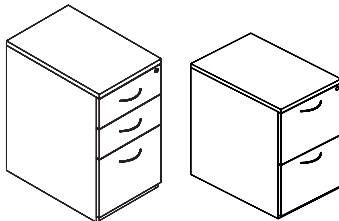

MMVFC

MMVF2

Vertical Files (H3B handles, lock)

Model#	Depth	Width	Height	20"D Drawers	Weight	Cube	Price
MMVF2	24"	16"	29"	2	160	7	\$864
MMVFC	24"	16"	29"	3	160	7	\$934

Upgrade to H3S Handle N/C.

NOTE: All files recommended capacity is 75%, do not overload.

For Handle upgrade, see p. 15.

maverick series

Upgrades and Accessories

(For Desks and Returns)

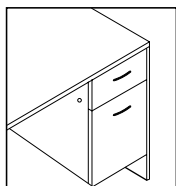

Package Upgrade (Includes 2 handles and 1 lock) for Box/File Pedestals

Model#	Price
MMUHL2	\$78

Specify package handle option. See below.

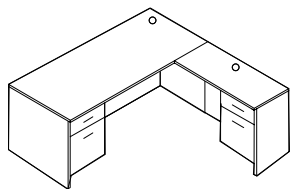

**Package Upgrade, For "L" Shape Box/File Ped Units
(Includes 2 grommets, 4 handles & 2 locks)**

Model#	Price
MMUGL	\$209

Grommets standard locations as shown. Specify package handle option. See below.

HANDLE OPTIONS FOR PACKAGES UHL2, UHL3, UGL



Crescent Black (MMH3B)



Crescent Silver (MMH3S)



Elliptical Black (MMH5B)



Elliptical Silver (MMH5S)



Crescent Textured Nickel (MMH6)



Flared Nickel (MMH7)



Bow Handle (MMH8)



Curved Handle (MMH9)



Bar Square Handle (MMH10B)



Bar Square Handle (MMH10S)



Bar Handle (MMH14)

maverick series

Upgrades and Accessories

HANDLE OPTIONS

H3B handle is standard for Utility Cabinets & Lateral Files, H3S may be specified N/C. Upgrade handles H5-H10B and H14, add \$16 each.



Individual handle option may be added to drawers or doors. Add \$32 list each. (lock not included)

GROMMETS

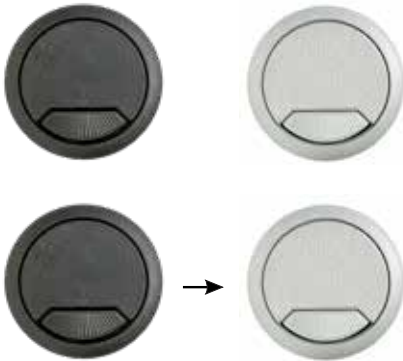

Grommet (Plastic cover, hole in surface, each)

Model#	Color	Depth	Width	Surface Hole Diameter	Price
MMGR234B	Black Plastic	3"	3"	2 3/4"	\$56
MMGR234S	Silver Plastic	3"	3"	2 3/4"	\$56

Specify grommet location.

Grommet Color Upgrade, from Standard Black to Silver

Model#	Color	Depth	Width	Surface Hole Diameter	Price
MMUGR234S	Silver Plastic	3"	3"	2 3/4"	N/C

Upgrade grommet color on items that are shown with standard grommets (i.e. MMCD72 4R)

GROMMET LOCATIONS (WORKSURFACE)

NOTE: While sitting at unit, grommet locations named from left to right.
For grommet location on tops and/or modesty panel specify left, center or right.
No grommets over pedestals.

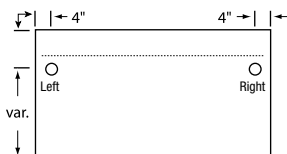

Desks

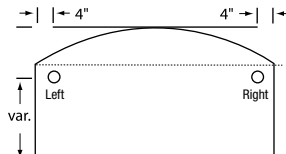

Desks

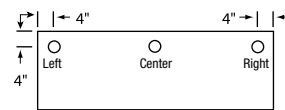

Credenza, Return, Bridges

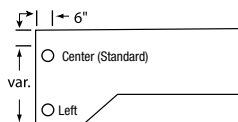

CompuCredenza

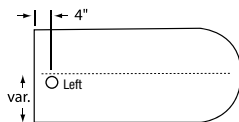

Bullets

maverick series

Accessories and Upgrades

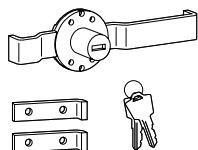

Pedestal Lock (Mounted on side of pedestal)

Model#	Description	Price
MMPL	Side pedestal lock	\$90

For **freestanding pedestals**, specify left or right side pedestal lock installation. Lock numbers are randomly assigned, key alike must be specified. No charge.

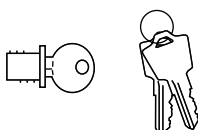

Face Lock

Model#	Description	Price
MMFL	Face lock for TFM doors or center drawers	\$90

MMFL: 1 per set of 2 doors. Hutch with four doors requires 2 locks. Lock numbers are randomly assigned, key alike must be specified. No charge.

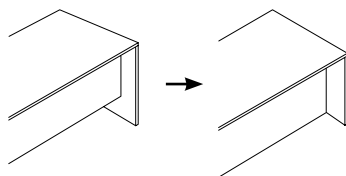

Full Modesty Panel Upgrade (From 3/4" modesty panel)

Model#	Depth	Width	Height	Weight	Cube	Price
MMFMP	3/4"	varies	28"	varies	varies	\$74

Option to upgrade from 3/4" modesty panel to full modesty panel.

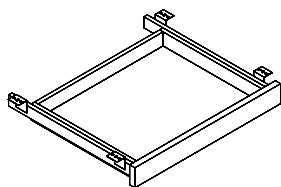

Center Drawer (9-ply birch wood drawer interior, specify front laminate color)

Model#	Depth	Width	Height	Weight	Cube	Price
MMCD	16"	21"	2 1/2"	12	.5	\$170

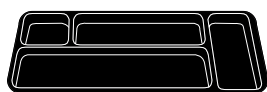

Box Drawer Convenience Tray, Black (Insets to box drawer)

Model#	Depth	Width	Height	Weight	Cube	Price
MMBPT	5 1/2"	12"	1"	1	.5	\$32

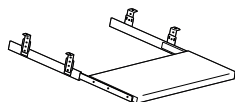

Keyboard Tray, Rollout (Specify laminate color)

Model#	Depth	Width	Height	Weight	Cube	Price
MMKB	16"	21"	3"	10	.5	\$156

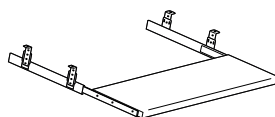

Oversize Keyboard Tray, Rollout (Specify laminate color)

Model#	Depth	Width	Height	Weight	Cube	Price
MMKBLG	16"	28"	3"	12	.5	\$230

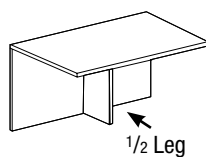

Half-Leg Support with Leveler (Finished 3-sides)

Model#	Depth	Width	Height	Weight	Cube	Price
MMSPT	12"	1"	28"	11	3	\$130

Support leg can also be used to create freestanding returns. Specify freestanding and left or right 1/2" leg. Required if placing hutch on L-unit return. Add to long pieces for support.

maverick complete



Maverick Complete, our most popular and complete series with the ability to mix and match any of our standard colors, provides modern day durability for any office space.

Features

Maverick Complete Series is standard with full modesty panel, full pedestals to floor, locking, handles. Hutch with fascia, grommets on credenzas, bridges and returns.

Edge Profile



Side View



maverick complete

Configurations

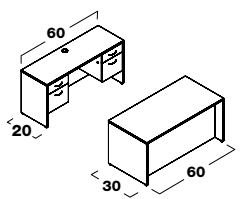

☞ MC1	
1 MCD3060	\$1,422
1 MCC2060 3	\$1,521
\$2,943	

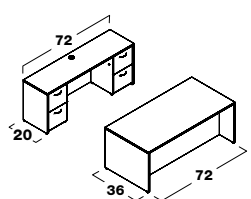

☞ MC2	
1 MCDC3672	\$2,393
1 MCCD2072 3	\$2,311
\$4,704	

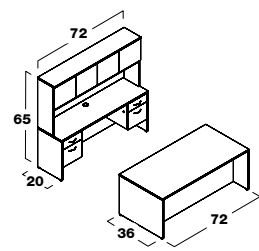

☞ MC3	
1 MCD3672	\$1,717
1 MCC2072 3	\$1,790
1 MCH72WD	\$1,574
\$5,081	

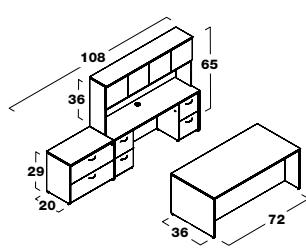

☞ MC4	
1 MCDC3672	\$2,393
1 MCCD2072 3	\$2,311
1 MCH72WD	\$1,574
1 MCLF202	\$1,259
\$7,537	

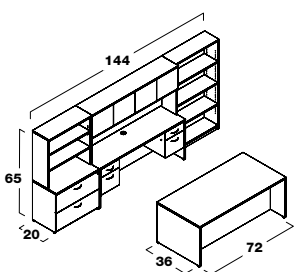

☞ MC5	
1 MCD3672	\$1,717
1 MCC2072 3	\$1,790
1 MCH72WD	\$1,574
1 MCLF202	\$1,259
1 MCBCH	\$520
1 MCBC3665	\$848
\$7,708	

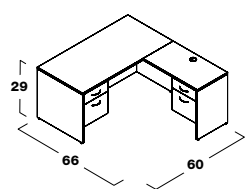

☞ MC6R	
1 MCS3060L	\$1,145
1 MCRA2036R	\$1,086
\$2,231	

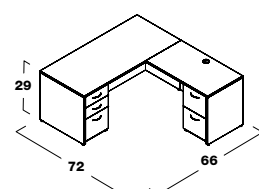

☞ MC7R	
1 MCSC3066L	\$1,747
1 MCRD2442R	\$1,625
\$3,372	

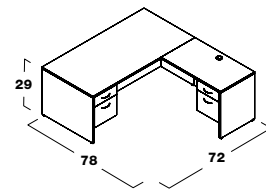

☞ MC8R	
1 MCS3672L	\$1,344
1 MCRA2442R	\$1,235
\$2,579	

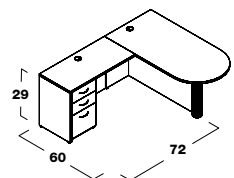

☞ MC9L	
1 MCB3060L	\$1,072
1 MCR2042L	\$1,586
\$2,658	

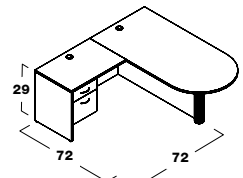

☞ MC10L	
1 MCB3672L	\$1,279
1 MCRA2436L	\$1,202
\$2,481	

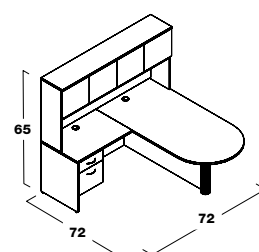

☞ MC11L	
1 MCB3672L	\$1,279
1 MCRA2436L	\$1,202
1 MCH72WD	\$1,574
\$4,055	

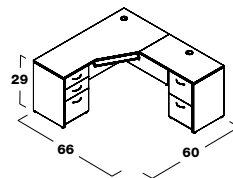

☞ MC12R	
1 MCCD66C 4L	\$1,921
1 MCRD2436R	\$1,614
\$3,535	

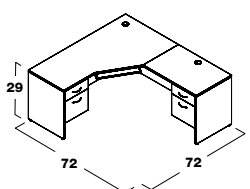

☞ MC13R	
1 MCCD72 4L	\$1,382
1 MCRA2436R	\$1,202
\$2,584	

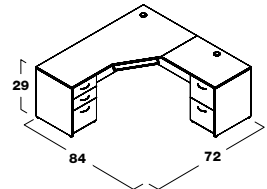

☞ MC14R	
1 MCCD72C 4L	\$1,859
1 MCRD2448R	\$1,661
\$3,520	

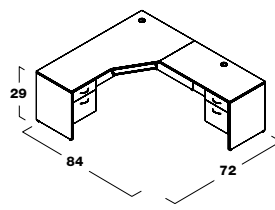

☞ MC15R	
1 MCCD72 4L	\$1,382
1 MCRA2448R	\$1,252
\$2,634	

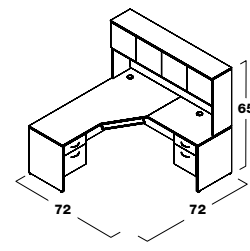

☞ MC16R	
1 MCCD72 4L	\$1,382
1 MCRA2436R	\$1,202
1 MCH72WD	\$1,574
\$4,158	

Use "R" or "L" to indicate the position of the return. Configurations are a small sample of total available. Configurations can be used with limited upgrade options for ☞.

maverick complete

Configurations

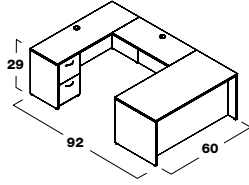

MC17L

1 MCSC3060R	\$1,625
1 MCBR2042	\$492
1 MCCD2060 4L	\$1,617
\$3,734	

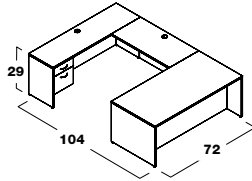

MC18L

1 MCS3672R	\$1,344
1 MCBR2448	\$648
1 MCC2072 4L	\$1,366
\$3,358	

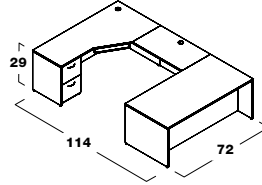

MC19L

1 MCSC3672R	\$1,826
1 MCBR2442	\$598
1 MCCD72D 4L	\$1,786
\$4,210	

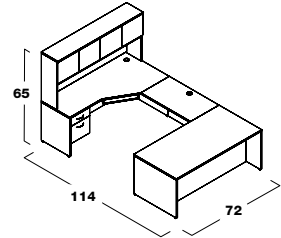

MC20L

1 MCS3672R	\$1,344
1 MCBR2442	\$598
1 MCCD72 4L	\$1,382
1 MCH72WD	\$1,574
\$4,898	

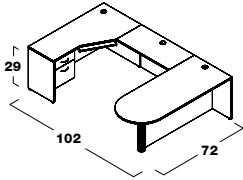

MC21L

1 MCB3072L	\$1,210
1 MCBR2042	\$492
1 MCCD60 2L	\$1,329
\$3,031	

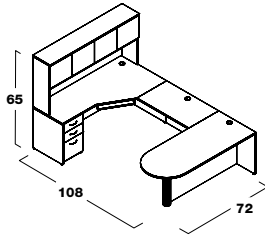

MC22L

1 MCB3072L	\$1,210
1 MCBR2442	\$598
1 MCCDC72 4L	\$1,859
1 MCH72WD	\$1,574
\$5,241	

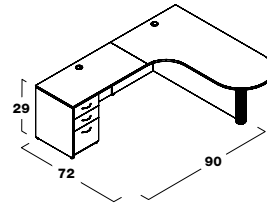

MCQ27L

1 MCBDCQ427230L	\$1,304
1 MCRC2448L	\$1,734
382	\$3,038

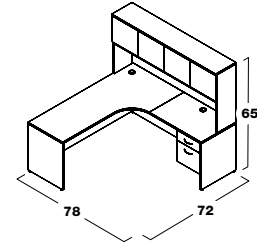

MCQ28R

1 MCCDNQ72 4R	\$1,175
1 MCRA2436R	\$1,202
1 MCH72WD	\$1,574
\$3,951	

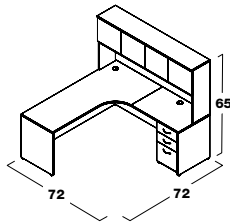

MCQ29R

1 MCCDNQ72 4R	\$1,175
1 MCRC2436R	\$1,683
1 MCH72WD	\$1,574
\$4,432	

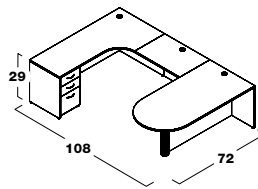

MCQ30L

1 MCB3672	\$1,279
1 MCBR2436	\$511
1 MCCDQ72C 4L	\$1,859
\$3,649	

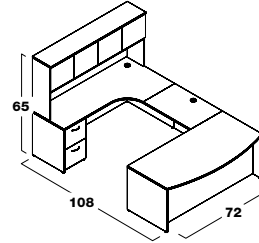

MCQ32L

1 MCFSC3672R	\$2,103
1 MCBR2436	\$511
1 MCCDQ72D 4L	\$1,789
1 MCH72WD	\$1,574
\$5,977	

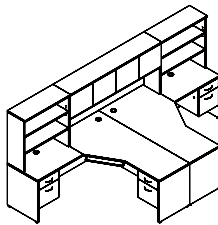

MC34

1 MCCD72 4R	\$1,382
1 MCCD72 4L	\$1,382
1 MCRA2436R	\$1,202
1 MCRA2436L	\$1,202
2 MCBC	\$1,040
1 MCH72 WD	\$1,574
\$7,782	

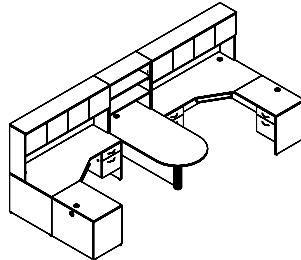

MC35

1 MCCD72 4R	\$1,382
1 MCCD72 4L	\$1,382
1 MCRA2436R	\$1,202
1 MCRA2436L	\$1,202
1 MCB3672L	\$1,279
2 MCH72WD	\$3,148
1 MCBC	\$520
\$10,115	

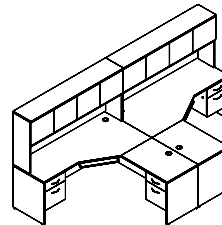

MC36

1 MCCD72 4R	\$1,382
1 MCCD72 4L	\$1,382
1 MCRA2436R	\$1,202
1 MCRA2436L	\$1,202
2 MCH72WD	\$3,148
\$8,316	

NOTE: BULLET DESK STAND ALONE w/ POST LEG WHEN ORDER AS MC35 CONFIGURATION, MUST SPECIFY.

maverick complete

Desks

Single Pedestal Desk, Box/File Pedestal Right (Full modesty, H3B handles, lock)

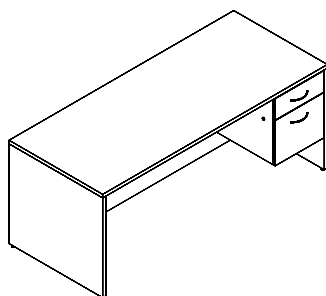

Model#	Depth	Width	Height	Weight	Cube	Price
☞ MCS2042R	20"	42"	29"	120	15	\$1,060
☞ MCS2060R	20"	60"	29"	150	20	\$1,130
☞ MCS2066R	20"	66"	29"	156	23	\$1,253
☞ MCS2072R	20"	72"	29"	163	24	\$1,267
☞ MCS2442R	24"	42"	29"	127	18	\$1,093
☞ MCS2448R	24"	48"	29"	130	20	\$1,112
☞ MCS3048R	30"	48"	29"	142	25	\$1,128
☞ MCS3060R	30"	60"	29"	190	32	\$1,145
☞ MCS3066R	30"	66"	29"	197	35	\$1,267
☞ MCS3072R	30"	72"	29"	210	38	\$1,286
☞ MCS3672R	36"	72"	29"	225	45	\$1,344

Single Pedestal Desk, Box/Box/File Pedestal Right (Full modesty, H3B handles, lock)

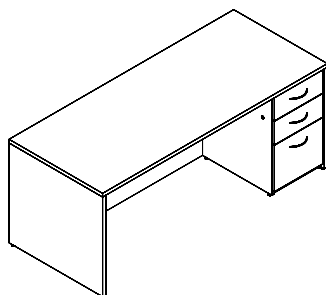

Model#	Depth	Width	Height	Weight	Cube	Price
☞ MCSC2042R	20"	42"	29"	155	15	\$1,539
☞ MCSC2060R	20"	60"	29"	180	20	\$1,606
☞ MCSC2066R	20"	66"	29"	190	23	\$1,729
☞ MCSC2072R	20"	72"	29"	200	24	\$1,747
☞ MCSC2442R	24"	42"	29"	175	18	\$1,574
☞ MCSC2448R	24"	48"	29"	183	20	\$1,593
☞ MCSC3048R	30"	48"	29"	203	25	\$1,606
☞ MCSC3060R	30"	60"	29"	224	32	\$1,625
☞ MCSC3066R	30"	66"	29"	234	35	\$1,747
☞ MCSC3072R	30"	72"	29"	244	38	\$1,764
☞ MCSC3672R	36"	72"	29"	267	45	\$1,826

Single Pedestal Desk, File/File Pedestal Right (Full modesty, H3B handles, lock)

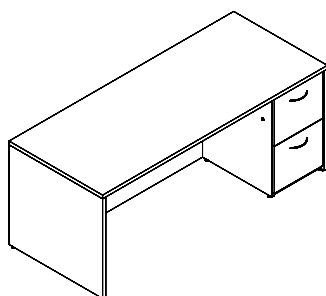

Model#	Depth	Width	Height	Weight	Cube	Price
☞ MCSD2042R	20"	42"	29"	155	15	\$1,469
☞ MCSD2060R	20"	60"	29"	180	20	\$1,537
☞ MCSD2066R	20"	66"	29"	190	23	\$1,659
☞ MCSD2072R	20"	72"	29"	200	24	\$1,674
☞ MCSD2442R	24"	42"	29"	175	18	\$1,502
☞ MCSD2448R	24"	48"	29"	183	20	\$1,522
☞ MCSD3048R	30"	48"	29"	203	25	\$1,537
☞ MCSD3060R	30"	60"	29"	224	32	\$1,555
☞ MCSD3066R	30"	66"	29"	234	35	\$1,674
☞ MCSD3072R	30"	72"	29"	244	38	\$1,695
☞ MCSD3672R	36"	72"	29"	267	45	\$1,755

See available accessories and upgrades, pp. 37-38.

Note: 60"W Single Pedestal Desks are recommended with 20"D Returns.

maverick complete

Desks

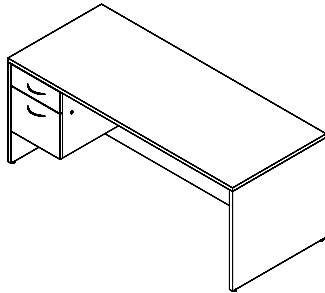

Single Pedestal Desk, Box/File Pedestal Left (Full modesty, H3B handles, lock)

Model#	Depth	Width	Height	Weight	Cube	Price
☞ MCS2042L	20"	42"	29"	120	15	\$1,060
☞ MCS2060L	20"	60"	29"	150	20	\$1,130
☞ MCS2066L	20"	66"	29"	156	23	\$1,253
☞ MCS2072L	20"	72"	29"	163	24	\$1,267
☞ MCS2442L	24"	42"	29"	127	18	\$1,093
☞ MCS2448L	24"	48"	29"	130	20	\$1,112
☞ MCS3048L	30"	48"	29"	142	25	\$1,128
☞ MCS3060L	30"	60"	29"	190	32	\$1,145
☞ MCS3066L	30"	66"	29"	197	35	\$1,267
☞ MCS3072L	30"	72"	29"	210	38	\$1,286
☞ MCS3672L	36"	72"	29"	225	45	\$1,344

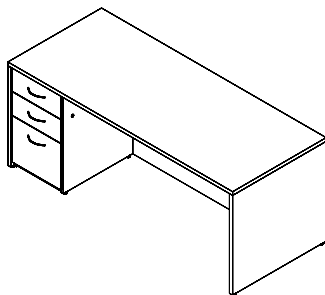

Single Pedestal Desk, Box/Box/File Pedestal Left (Full modesty, H3B handles, lock)

Model#	Depth	Width	Height	Weight	Cube	Price
☞ MCSC2042L	20"	42"	29"	120	15	\$1,539
☞ MCSC2060L	20"	60"	29"	150	20	\$1,606
☞ MCSC2066L	20"	66"	29"	156	23	\$1,729
☞ MCSC2072L	20"	72"	29"	163	24	\$1,747
☞ MCSC2442L	24"	42"	29"	127	18	\$1,574
☞ MCSC2448L	24"	48"	29"	130	20	\$1,593
☞ MCSC3048L	30"	48"	29"	142	25	\$1,606
☞ MCSC3060L	30"	60"	29"	190	32	\$1,625
☞ MCSC3066L	30"	66"	29"	197	35	\$1,747
☞ MCSC3072L	30"	72"	29"	210	38	\$1,764
☞ MCSC3672L	36"	72"	29"	225	45	\$1,826

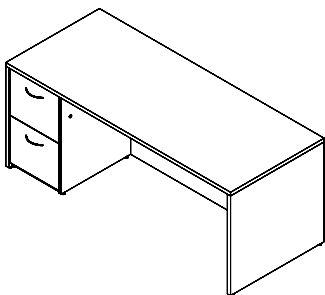

Single Pedestal Desk, File/File Pedestal Left (Full modesty, H3B handles, lock)

Model#	Depth	Width	Height	Weight	Cube	Price
☞ MCSD2042L	20"	42"	29"	120	15	\$1,469
☞ MCSD2060L	20"	60"	29"	150	20	\$1,537
☞ MCSD2066L	20"	66"	29"	156	23	\$1,659
☞ MCSD2072L	20"	72"	29"	163	24	\$1,674
☞ MCSD2442L	24"	42"	29"	127	18	\$1,502
☞ MCSD2448L	24"	48"	29"	130	20	\$1,522
☞ MCSD3048L	30"	48"	29"	142	25	\$1,537
☞ MCSD3060L	30"	60"	29"	190	32	\$1,555
☞ MCSD3066L	30"	66"	29"	197	35	\$1,674
☞ MCSD3072L	30"	72"	29"	210	38	\$1,695
☞ MCSD3672L	36"	72"	29"	225	45	\$1,755

See available accessories and upgrades, pp. 37-38.

Note: 60"W Single Pedestal Desks are recommended with 20"D Returns.

maverick complete

Desks

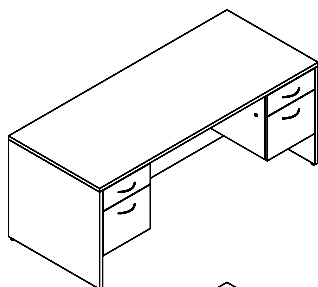

Double Pedestal Desk, Box/File Pedestals Left and Right
(Full modesty, H3B Handles, 2 Locks)

Model#	Depth	Width	Height	Weight	Cube	Price
☞ MCD3060	30"	60"	29"	260	32	\$1,422
☞ MCD3066	30"	66"	29"	266	35	\$1,676
☞ MCD3072	30"	72"	29"	270	38	\$1,700
☞ MCD3672	36"	72"	29"	276	45	\$1,717

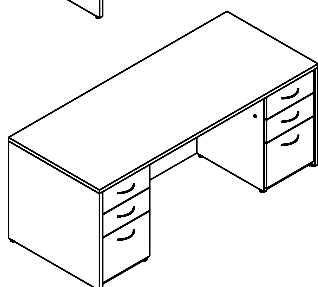

Double Pedestal Desk, Box/Box/File Pedestals Left and Right
(Full Modesty, H3B Handles, 2 Locks)

Model#	Depth	Width	Height	Weight	Cube	Price
☞ MCDC3060	30"	60"	29"	294	32	\$2,042
☞ MCDC3066	30"	66"	29"	304	35	\$2,350
☞ MCDC3072	30"	72"	29"	314	38	\$2,377
☞ MCDC3672	36"	72"	29"	337	45	\$2,393

For left Box/Box/File and right File/File configuration use MCDCD ____ N/C.

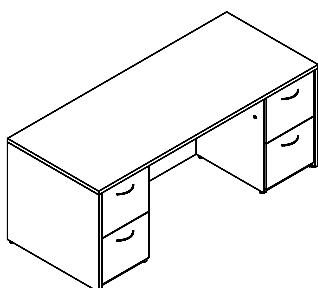

Double Pedestal Desk, File/File Pedestals Left and Right
(Full Modesty, H3B Handles, 2 Locks)

Model#	Depth	Width	Height	Weight	Cube	Price
☞ MCDD3060	30"	60"	29"	294	32	\$1,948
☞ MCDD3066	30"	66"	29"	304	35	\$2,256
☞ MCDD3072	30"	72"	29"	314	38	\$2,281
☞ MCDD3672	36"	72"	29"	337	45	\$2,299

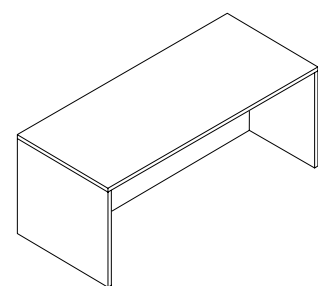

Desk Shell No-Pedestal, Full Modesty (Flush Modesty)

Model#	Depth	Width	Height	Weight	Cube	Price
☞ MCN2042	20"	42"	29"	84	17	\$610
☞ MCN2048	20"	48"	29"	84	17	\$626
☞ MCN2060	20"	60"	29"	92	20	\$671
☞ MCN2066	20"	66"	29"	96	23	\$713
☞ MCN2072	20"	72"	29"	100	24	\$731
☞ MCN2436	24"	36"	29"	89	16	\$618
☞ MCN2442	24"	42"	29"	95	18	\$671
☞ MCN2448	24"	48"	29"	104	20	\$687
☞ MCN2460	24"	60"	29"	120	25	\$731
☞ MCN2466	24"	66"	29"	127	28	\$818
☞ MCN2472	24"	72"	29"	132	30	\$870

For left or right 1/2 leg specify on order...N/C. Modesty is flush.

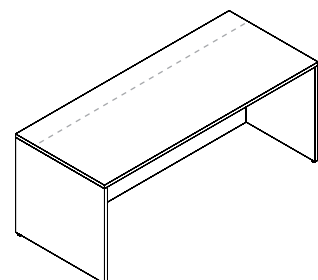

Desk Shell No-Pedestal, Full Modesty (30"D-6" Inset Modesty, 36"D-12" Inset Modesty)

Model#	Depth	Width	Height	Weight	Cube	Price
☞ MCN3042	30"	42"	29"	114	22	\$731
☞ MCN3048	30"	48"	29"	120	25	\$750
☞ MCN3060	30"	60"	29"	126	32	\$767
☞ MCN3066	30"	66"	29"	132	35	\$846
☞ MCN3072	30"	72"	29"	138	38	\$870
☞ MCN3672	36"	72"	29"	152	45	\$887

For left or right 1/2 leg specify on order...N/C. Modesty is Inset 6" on 30"D & 12" on 36"D.

See available accessories and upgrades, pp. 37-38.

Note: 60"W Single Pedestal Desks are recommended with 20"D Returns.

maverick complete

Desks

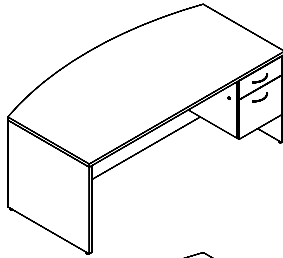

Fan Top Single Pedestal Desk, Box/File Right (Full Modesty, H3B Handles, Lock)

Model#	Depth	Width	Height	Weight	Cube	Price
☞ MCFSC3672R	30-36"	72"	29"	233	45	\$1,622
☞ MCFSC4272R	36-42"	72"	29"	258	53	\$1,673

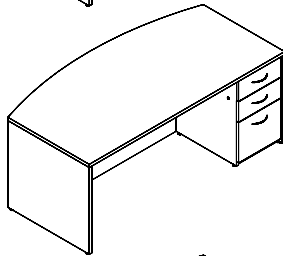

Fan Top Single Pedestal Desk, Box/Box/File Right (Full Modesty, H3B Handles, Lock)

Model#	Depth	Width	Height	Weight	Cube	Price
☞ MCFSC3672R	30-36"	72"	29"	265	45	\$2,103
☞ MCFSC4272R	36-42"	72"	29"	280	53	\$2,153

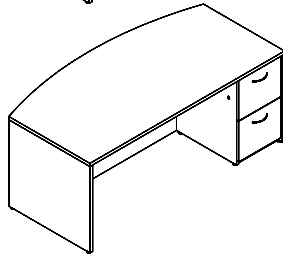

Fan Top Single Pedestal Desk, File/File Right (Full Modesty, H3B Handles, Lock)

Model#	Depth	Width	Height	Weight	Cube	Price
☞ MCFSD3672R	30-36"	72"	29"	265	45	\$2,032
☞ MCFSD4272R	36-42"	72"	29"	280	53	\$2,081

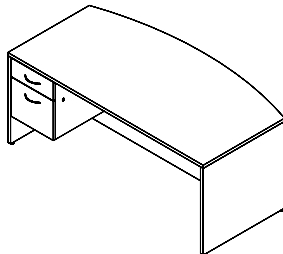

Fan Top Single Pedestal Desk, Box/File Left (Full Modesty, H3B Handles, Lock)

Model#	Depth	Width	Height	Weight	Cube	Price
☞ MCFSC3672L	30-36"	72"	29"	233	45	\$1,622
☞ MCFSC4272L	36-42"	72"	29"	258	53	\$1,673

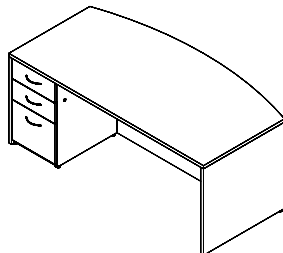

Fan Top Single Pedestal Desk, Box/Box/File Left (Full Modesty, H3B Handles, Lock)

Model#	Depth	Width	Height	Weight	Cube	Price
☞ MCFSC3672L	30-36"	72"	29"	265	45	\$2,103
☞ MCFSC4272L	36-42"	72"	29"	280	53	\$2,153

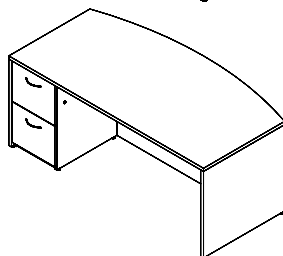

Fan Top Single Pedestal Desk, File/File Left (Full Modesty, H3B Handles, Lock)

Model#	Depth	Width	Height	Weight	Cube	Price
☞ MCFSD3672L	30-36"	72"	29"	265	45	\$2,032
☞ MCFSD4272L	36-42"	72"	29"	280	53	\$2,081

See available accessories and upgrades, pp. 37-38.

maverick complete

Desks

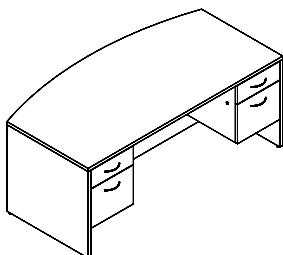

Fan Top Double Pedestal, Box/File Left and Right
(Full Modesty, H3B Handles, 2 Locks)

Model#	Depth	Width	Height	Weight	Cube	Price
☞ MCFD3672	30-36"	72"	29"	280	45	\$2,023
☞ MCFD4272	36-42"	72"	29"	305	53	\$2,038

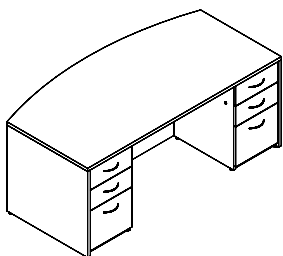

Fan Top Double Pedestal Desk, Box/Box/File Left and Right
(Full Modesty, H3B Handles, 2 Locks)

Model#	Depth	Width	Height	Weight	Cube	Price
☞ MCFDC3672	30-36"	72"	29"	335	45	\$2,639
☞ MCFDC4272	36-42"	72"	29"	350	53	\$2,654

For left Box/Box/File and right File/File configuration use MCD CD ____ N/C.

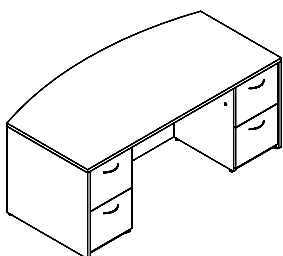

Fan Top Double Pedestal Desk, File/File Left and Right
(Full Modesty, H3B Handles, 2 Locks)

Model#	Depth	Width	Height	Weight	Cube	Price
☞ MCFDD3672	30-36"	72"	29"	335	45	\$2,544
☞ MCFDD4272	36-42"	72"	29"	350	53	\$2,558

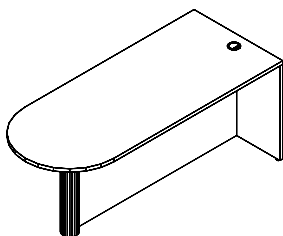

Bullet Desk, (Full modesty, 4" black post, centered black grommet) For Right Return

Model#	Depth	Width	Height	Weight	Cube	Price
☞ MCBD3060R	30"	60"	29"	180	32	\$1,072
☞ MCBD3072R	30"	72"	29"	195	35	\$1,210
☞ MCBD3660R	36"	60"	29"	185	38	\$1,210
☞ MCBD3672R	36"	72"	29"	205	45	\$1,279

For silver post upgrade, add MM UHLEGJS...\$34. Upgrade grommet cover to silver, N/C.
Specify if standalone, standalone is made with ½ leg (MMSPT) at no charge, replaces post leg.

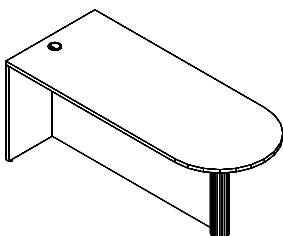

Bullet Desk, (Full modesty, 4" black post, centered black grommet) For Left Return

Model#	Depth	Width	Height	Weight	Cube	Price
☞ MCBD3060L	30"	60"	29"	180	32	\$1,072
☞ MCBD3072L	30"	72"	29"	195	35	\$1,210
☞ MCBD3660L	36"	60"	29"	185	38	\$1,210
☞ MCBD3672L	36"	72"	29"	205	45	\$1,279

For silver post upgrade, add MM UHLEGJS...\$34. Upgrade grommet cover to silver, N/C.
Specify if standalone, standalone is made with ½ leg (MMSPT) at no charge, replaces post leg.

See available accessories and upgrades, pp. 37-38.

maverick complete

Desks

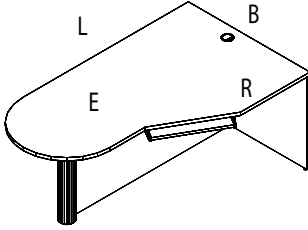

Bullet Computer Desk (Full modesty, 4" black post) For Right Return

Model#	Depth (B,E)	Width (L,R)	Height	Weight	Cube	Price
☞ MCBDC427230R	42/30"	72"/24"	29"	195	53	\$1,304
☞ MCBDC427830R	42/30"	78"/24"	29"	205	58	\$1,579

Keyboard tray and worksurface black grommet are standard. Upgrade grommet cover to silver, N/C. For silver post upgrade, add MM UHLEGJS...\$34.

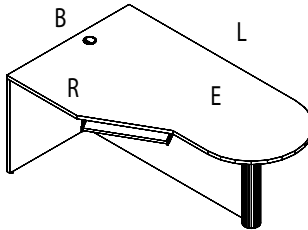

Bullet Computer Desk (Full modesty, 4" black post) For Left Return

Model#	Depth (B,E)	Width (L,R)	Height	Weight	Cube	Price
☞ MCBDC427230L	42/30"	72"/24"	29"	195	53	\$1,304
☞ MCBDC427830L	42/30"	78"/24"	29"	205	58	\$1,579

Keyboard tray and worksurface black grommet are standard. Upgrade grommet cover to silver, N/C. For silver post upgrade, add MM UHLEGJS...\$34.

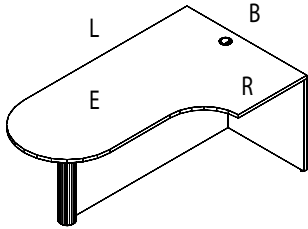

Bullet Computer Desk, Curved (Full modesty, 4" black post) For Right Return

Model#	Depth (B,E)	Width (L,R)	Height	Weight	Cube	Price
☞ MCBDCQ427230R	42/30"	72"/24"	29"	195	53	\$1,304

Worksurface black grommet standard. Upgrade grommet cover to silver, N/C. For silver post upgrade, add MM UHLEGJS...\$34.

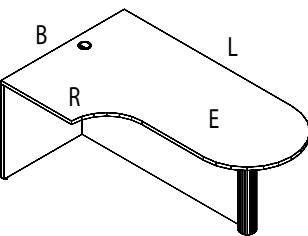

Bullet Computer Desk, Curved (Full modesty, 4" black post) For Left Return

Model#	Depth (B,E)	Width (L,R)	Height	Weight	Cube	Price
☞ MCBDCQ427230L	42/30"	72"/24"	29"	195	53	\$1,304

Worksurface black grommet standard. Upgrade grommet cover to silver, N/C. For silver post upgrade, add MM UHLEGJS...\$34.

NOTE: All bullet computer desks specify if standalone. Standalone is made with ½ leg (MMSPT) at no charge, replaces post leg.

maverick complete

Bridges

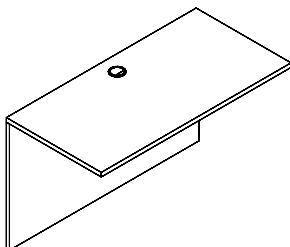

Bridge Full Modesty (Flush height)

Model#	Depth	Width	Height	Weight	Cube	Price
☞ MCBR2036	20"	36"	29"	41	9	\$473
☞ MCBR2042	20"	42"	29"	48	10	\$492
☞ MCBR2048	20"	48"	29"	55	12	\$545
☞ MCBR2436	24"	36"	29"	47	10	\$511
☞ MCBR2442	24"	42"	29"	55	12	\$598
☞ MCBR2448	24"	48"	29"	63	14	\$648
☞ MCBR2460	24"	60"	29"	78	15	\$746

Full modesty standard. ½ modesty on bridges may be specified at no upcharge.
 Black grommet center top and modesty. Upgrade grommet cover to silver, N/C.
 60"W bridge requires ½ leg center support, add MM SPT \$130. (Grommet is offset to clear half leg)

Returns

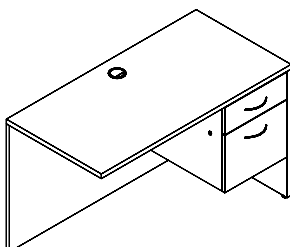

Return, ¾ Box/File Pedestal Right (Full modesty, flush height, H3B Handles, Lock)

Model#	Depth	Width	Height	Weight	Cube	Price
☞ MCRA2036R	20"	36"	29"	95	13	\$1,086
☞ MCRA2042R	20"	42"	29"	104	15	\$1,102
☞ MCRA2048R	20"	48"	29"	110	17	\$1,121
☞ MCRA2054R	20"	54"	29"	117	19	\$1,155
☞ MCRA2436R	24"	36"	29"	100	15	\$1,202
☞ MCRA2442R	24"	42"	29"	107	18	\$1,235
☞ MCRA2448R	24"	48"	29"	114	20	\$1,252
☞ MCRA2454R	24"	54"	29"	121	23	\$1,322
☞ MCRA2460R	24"	60"	29"	124	24	\$1,340
☞ MCRA3048R	30"	48"	29"	127	25	\$1,340

Full modesty standard. ½ modesty on returns may be specified at no upcharge.
 Black grommet center top and modesty. Upgrade grommet cover to silver, N/C.

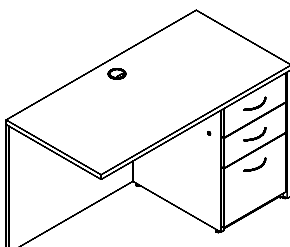

Return, Box/Box/File Pedestal Right (Full modesty, H3B Handles, Lock)

Model#	Depth	Width	Height	Weight	Cube	Price
☞ MCRC2036R	20"	36"	29"	130	13	\$1,569
☞ MCRC2042R	20"	42"	29"	140	15	\$1,586
☞ MCRC2048R	20"	48"	29"	150	17	\$1,606
☞ MCRC2054R	20"	54"	29"	160	19	\$1,641
☞ MCRC2436R	24"	36"	29"	140	15	\$1,683
☞ MCRC2442R	24"	42"	29"	150	18	\$1,719
☞ MCRC2448R	24"	48"	29"	160	20	\$1,734
☞ MCRC2454R	24"	54"	29"	170	23	\$1,807
☞ MCRC2460R	24"	60"	29"	180	24	\$1,821
☞ MCRC3048R	30"	48"	29"	175	25	\$1,821

Full modesty standard. ½ modesty on returns may be specified at no upcharge.
 Black grommet center top and modesty. Upgrade grommet cover to silver, N/C.

NOTE: If placing hutch on L-unit return ½ support is required, add MMSPT \$130.

See available accessories and upgrades, pp. 37-38.

maverick complete

Returns

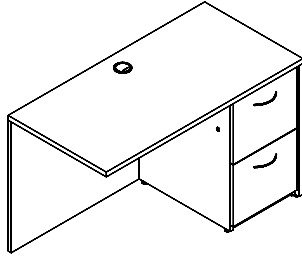

Return, File/File Pedestal Right (Full modesty, H3B Handles, Lock)

Model#	Depth	Width	Height	Weight	Cube	Price
☞ MCRD2036R	20"	36"	29"	130	13	\$1,496
☞ MCRD2042R	20"	42"	29"	140	15	\$1,513
☞ MCRD2048R	20"	48"	29"	150	17	\$1,532
☞ MCRD2054R	20"	54"	29"	160	19	\$1,568
☞ MCRD2436R	24"	36"	29"	140	15	\$1,614
☞ MCRD2442R	24"	42"	29"	150	18	\$1,625
☞ MCRD2448R	24"	48"	29"	160	20	\$1,661
☞ MCRD2454R	24"	54"	29"	170	23	\$1,735
☞ MCRD2460R	24"	60"	29"	180	24	\$1,747
☞ MCRD3048R	30"	48"	29"	175	25	\$1,747

Full modesty standard. ½ modesty on returns may be specified at no upcharge.
Black grommet center top and modesty. Upgrade grommet cover to silver, N/C.

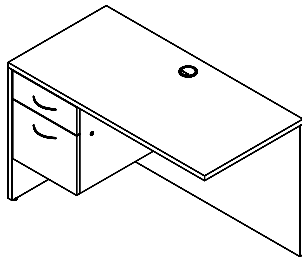

Return, ¾ Box/File Pedestal Left (Full modesty, H3B Handles, Lock)

Model#	Depth	Width	Height	Weight	Cube	Price
☞ MCRA2036L	20"	36"	29"	95	13	\$1,086
☞ MCRA2042L	20"	42"	29"	104	15	\$1,102
☞ MCRA2048L	20"	48"	29"	110	17	\$1,121
☞ MCRA2054L	20"	54"	29"	117	19	\$1,155
☞ MCRA2436L	24"	36"	29"	100	15	\$1,202
☞ MCRA2442L	24"	42"	29"	107	18	\$1,235
☞ MCRA2448L	24"	48"	29"	114	20	\$1,252
☞ MCRA2454L	24"	54"	29"	121	23	\$1,322
☞ MCRA2460L	24"	60"	29"	124	24	\$1,340
☞ MCRA3048L	30"	48"	29"	127	25	\$1,340

Full modesty standard. ½ modesty on returns may be specified at no upcharge.
Black grommet center top and modesty. Upgrade grommet cover to silver, N/C.

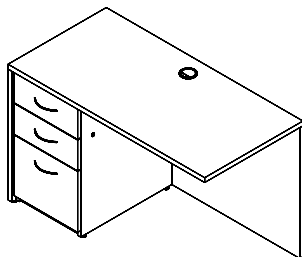

Return, Box/Box/File Pedestal Left (Full modesty, H3B Handles, Lock)

Model#	Depth	Width	Height	Weight	Cube	Price
☞ MCRC2036L	20"	36"	29"	130	13	\$1,569
☞ MCRC2042L	20"	42"	29"	140	15	\$1,586
☞ MCRC2048L	20"	48"	29"	150	17	\$1,606
☞ MCRC2054L	20"	54"	29"	160	19	\$1,641
☞ MCRC2436L	24"	36"	29"	140	15	\$1,683
☞ MCRC2442L	24"	42"	29"	150	18	\$1,719
☞ MCRC2448L	24"	48"	29"	160	20	\$1,734
☞ MCRC2454L	24"	54"	29"	170	23	\$1,807
☞ MCRC2460L	24"	60"	29"	180	24	\$1,821
☞ MCRC3048L	30"	48"	29"	175	25	\$1,821

Full modesty standard. ½ modesty on returns may be specified at no upcharge.
Black grommet center top and modesty. Upgrade grommet cover to silver, N/C.

NOTE: If placing hutch on L-unit return ½ support is required, add MMSPT \$130.

See available accessories and upgrades, pp. 37-38.

maverick complete

Returns

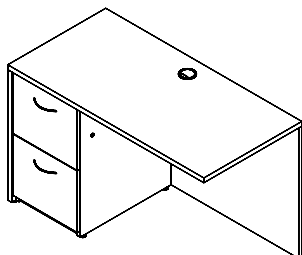

Return, File/File Pedestal Left (Full modesty, H3B Handles, Lock)

Model#	Depth	Width	Height	Weight	Cube	Price
☞ MCRD2036L	20"	36"	29"	130	13	\$1,496
☞ MCRD2042L	20"	42"	29"	140	15	\$1,513
☞ MCRD2048L	20"	48"	29"	150	17	\$1,532
☞ MCRD2054L	20"	54"	29"	160	19	\$1,568
☞ MCRD2436L	24"	36"	29"	140	15	\$1,614
☞ MCRD2442L	24"	42"	29"	150	18	\$1,625
☞ MCRD2448L	24"	48"	29"	160	20	\$1,661
☞ MCRD2454L	24"	54"	29"	170	23	\$1,735
☞ MCRD2460L	24"	60"	29"	180	24	\$1,747
☞ MCRD3048L	30"	48"	29"	175	25	\$1,747

Full modesty standard. ½ modesty on returns may be specified at no upcharge.
Black grommet center top and modesty. Upgrade grommet cover to silver, N/C.

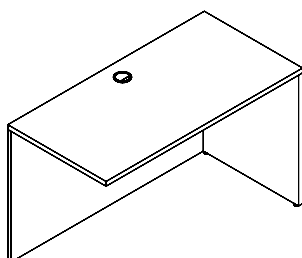

Return Shell Right (Full modesty)

Model#	Depth	Width	Height	Weight	Cube	Price
☞ MCRN2036R	20"	36"	29"	60	13	\$598
☞ MCRN2042R	20"	42"	29"	67	15	\$615
☞ MCRN2048R	20"	48"	29"	73	17	\$674
☞ MCRN2054R	20"	54"	29"	80	19	\$729
☞ MCRN2436R	24"	36"	29"	63	15	\$738
☞ MCRN2442R	24"	42"	29"	67	18	\$771
☞ MCRN2448R	24"	48"	29"	74	20	\$809
☞ MCRN2454R	24"	54"	29"	80	23	\$849
☞ MCRN3048R	30"	48"	29"	89	25	\$900

Full modesty standard. ½ modesty on returns may be specified at no upcharge.
Black grommet center top and modesty. Upgrade grommet cover to silver, N/C.

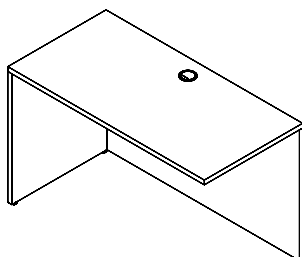

Return Shell Left (Full modesty)

Model#	Depth	Width	Height	Weight	Cube	Price
☞ MCRN2036L	20"	36"	29"	60	13	\$598
☞ MCRN2042L	20"	42"	29"	67	15	\$615
☞ MCRN2048L	20"	48"	29"	73	17	\$674
☞ MCRN2054L	20"	54"	29"	80	19	\$729
☞ MCRN2436L	24"	36"	29"	63	15	\$738
☞ MCRN2442L	24"	42"	29"	67	18	\$771
☞ MCRN2448L	24"	48"	29"	74	20	\$809
☞ MCRN2454L	24"	54"	29"	80	23	\$849
☞ MCRN3048L	30"	48"	29"	89	25	\$900

Full modesty standard. ½ modesty on returns may be specified at no upcharge.
Black grommet center top and modesty. Upgrade grommet cover to silver, N/C.

NOTE: If placing hutch on L-unit return ½ support is required, add MMSPT \$130.

See available accessories and upgrades, pp. 37-38.

maverick complete

Credenzas

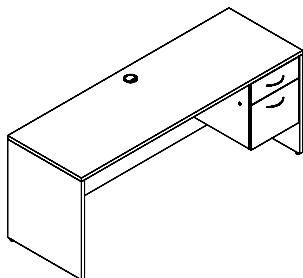

Credenza, Single Box/File Pedestal Right (Full modesty, H3B handles, lock)

Model#	Depth	Width	Height	Weight	Cube	Price
☞ MCC2060 4R	20"	60"	29"	150	21	\$1,226
☞ MCC2066 4R	20"	66"	29"	157	23	\$1,345
☞ MCC2072 4R	20"	72"	29"	164	25	\$1,366
☞ MCC2472 4R	24"	72"	29"	168	30	\$1,399

Black grommet center top and modesty. Upgrade grommet cover to silver, N/C.

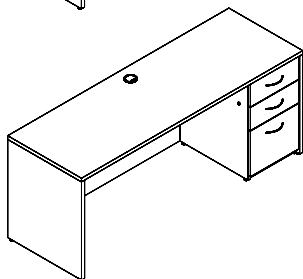

Credenza, Single Box/Box/File Pedestal Right (Full modesty, H3B handles, lock)

Model#	Depth	Width	Height	Weight	Cube	Price
☞ MCCC2060 4R	20"	60"	29"	185	21	\$1,691
☞ MCCC2066 4R	20"	66"	29"	190	23	\$1,824
☞ MCCC2072 4R	20"	72"	29"	200	25	\$1,842
☞ MCCC2472 4R	24"	72"	29"	220	30	\$1,879

Black grommet center top and modesty. Upgrade grommet cover to silver, N/C.

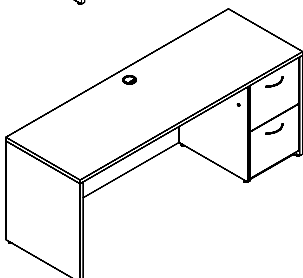

Credenza, Single File/File Pedestal Right (Full modesty, H3B handles, lock)

Model#	Depth	Width	Height	Weight	Cube	Price
☞ MCCD2060 4R	20"	60"	29"	183	21	\$1,617
☞ MCCD2066 4R	20"	66"	29"	190	23	\$1,755
☞ MCCD2072 4R	20"	72"	29"	200	25	\$1,772
☞ MCCD2472 4R	24"	72"	29"	220	30	\$1,808

Black grommet center top and modesty. Upgrade grommet cover to silver, N/C.

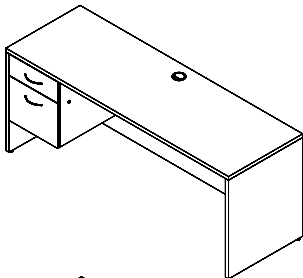

Credenza, Single Box/File Pedestal Left (Full modesty, H3B handles, lock)

Model#	Depth	Width	Height	Weight	Cube	Price
☞ MCC2060 4L	20"	60"	29"	150	21	\$1,226
☞ MCC2066 4L	20"	66"	29"	157	23	\$1,345
☞ MCC2072 4L	20"	72"	29"	164	25	\$1,366
☞ MCC2472 4L	24"	72"	29"	168	30	\$1,399

Black grommet center top and modesty. Upgrade grommet cover to silver, N/C.

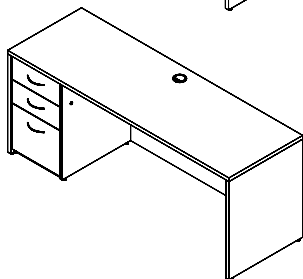

Credenza, Single Box/Box/File Pedestal Left (Full modesty, H3B handles, lock)

Model#	Depth	Width	Height	Weight	Cube	Price
☞ MCCC2060 4L	20"	60"	29"	185	21	\$1,691
☞ MCCC2066 4L	20"	66"	29"	190	23	\$1,824
☞ MCCC2072 4L	20"	72"	29"	200	25	\$1,842
☞ MCCC2472 4L	24"	72"	29"	220	30	\$1,879

Black grommet center top and modesty. Upgrade grommet cover to silver, N/C.

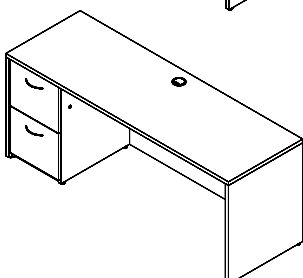

Credenza, Single File/File Pedestal Left (Full modesty, H3B handles, lock)

Model#	Depth	Width	Height	Weight	Cube	Price
☞ MCCD2060 4L	20"	60"	29"	183	21	\$1,617
☞ MCCD2066 4L	20"	66"	29"	190	23	\$1,755
☞ MCCD2072 4L	20"	72"	29"	200	25	\$1,772
☞ MCCD2472 4L	24"	72"	29"	220	30	\$1,808

Black grommet center top and modesty. Upgrade grommet cover to silver, N/C.

See available accessories and upgrades, pp. 37-38.

maverick complete

CompuCorner Credenzas

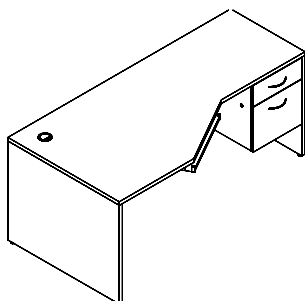

Computer Corner, Box/File Pedestal Right (H3B handles, lock, Full modesty)

Model#	(L)	(B)	(E)	(K)	(R)	(W)	Weight	Cube	Price
☞ MCCD60 2R	60"	30"	20"	21"	20"	21"	220	32	\$1,329
☞ MCCD60 4R	60"	36"	24"	21"	24"	22"	220	32	\$1,345
☞ MCCD66 4R	66"	36"	24"	21"	24"	24"	229	42	\$1,440
☞ MCCD72 3R	72"	36"	20"	24"	20"	33"	249	45	\$1,521
☞ MCCD72 4R	72"	36"	24"	21"	24"	30"	249	45	\$1,382
☞ MCCD72 7R	72"	36"	24"	23"	20"	32"	285	45	\$1,501
☞ MCCD72 8R	72"	42"	24"	24"	24"	33"	285	53	\$1,804

Keyboard tray and worksurface black grommet standard. Upgrade grommet cover to silver, N/C.

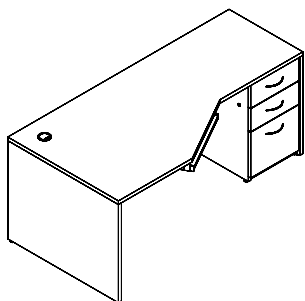

Computer Corner, Box/Box/File Pedestal Right (H3B handles, lock, Full modesty)

Model#	(L)	(B)	(E)	(K)	(R)	(W)	Weight	Cube	Price
☞ MCCD60C 2R	60"	30"	20"	21"	20"	21"	235	32	\$1,808
☞ MCCD60C 4R	60"	36"	24"	21"	24"	22"	235	32	\$1,828
☞ MCCD66C 4R	66"	36"	24"	21"	24"	24"	245	42	\$1,921
☞ MCCD72C 3R	72"	36"	20"	24"	20"	33"	265	45	\$1,998
☞ MCCD72C 4R	72"	36"	24"	21"	24"	30"	265	45	\$1,859
☞ MCCD72C 7R	72"	36"	24"	23"	20"	32"	300	45	\$1,981
☞ MCCD72C 8R	72"	42"	24"	24"	24"	33"	300	53	\$2,285

Keyboard tray and worksurface black grommet standard. Upgrade grommet cover to silver, N/C.

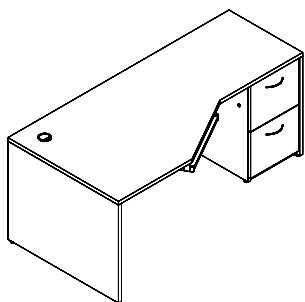

Computer Corner, File/File Pedestal Right (H3B handles, lock, Full modesty)

Model#	(L)	(B)	(E)	(K)	(R)	(W)	Weight	Cube	Price
☞ MMCD60D 2R	60"	30"	20"	21"	20"	21"	235	32	\$1,734
☞ MMCD60D 4R	60"	36"	24"	21"	24"	22"	235	32	\$1,756
☞ MCD66D 4R	66"	36"	24"	21"	24"	24"	245	42	\$1,786
☞ MCD72D 3R	72"	36"	20"	24"	20"	33"	265	45	\$1,866
☞ MCD72D 4R	72"	36"	24"	21"	24"	30"	265	45	\$1,786
☞ MCD72D 7R	72"	36"	24"	23"	20"	32"	300	45	\$1,907
☞ MCD72D 8R	72"	42"	24"	24"	24"	33"	300	53	\$2,212

Keyboard tray and worksurface black grommet standard. Upgrade grommet cover to silver, N/C.

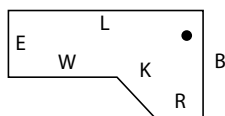

"L" Length along approach edge

"B" Back end panel

"E" End panel

"K" Keyboard space

"R" Return size to attach

"W" Workarea (kbrd to end)

maverick complete

CompuCorner Credenzas

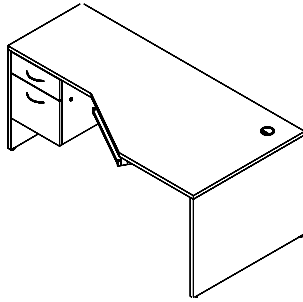

Computer Corner, Box/File Pedestal Left (H3B handles, lock, Full modesty)

Model#	(L)	(B)	(E)	(K)	(R)	(W)	Weight	Cube	Price
MCCD60 2L	60"	30"	20"	21"	20"	21"	220	32	\$1,329
MCCD60 4L	60"	36"	24"	21"	24"	22"	220	32	\$1,345
MCCD66 4L	66"	36"	24"	21"	24"	24"	229	42	\$1,440
MCCD72 3L	72"	36"	20"	24"	20"	33"	249	45	\$1,521
MCCD72 4L	72"	36"	24"	21"	24"	30"	249	45	\$1,382
MCCD72 7L	72"	36"	24"	23"	20"	32"	285	45	\$1,501
MCCD72 8L	72"	42"	24"	24"	24"	33"	285	53	\$1,804

Keyboard tray and worksurface black grommet standard. Upgrade grommet cover to silver, N/C.

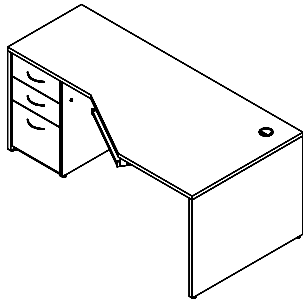

Computer Corner, Box/Box/File Pedestal Left (H3B handles, lock, Full modesty)

Model#	(L)	(B)	(E)	(K)	(R)	(W)	Weight	Cube	Price
MCCD60C 2L	60"	30"	20"	21"	20"	21"	235	32	\$1,808
MCCD60C 4L	60"	36"	24"	21"	24"	22"	235	32	\$1,828
MCCD66C 4L	66"	36"	24"	21"	24"	24"	245	42	\$1,921
MCCD72C 3L	72"	36"	20"	24"	20"	33"	265	45	\$1,998
MCCD72C 4L	72"	36"	24"	21"	24"	30"	265	45	\$1,859
MCCD72C 7L	72"	36"	24"	23"	20"	32"	300	45	\$1,981
MCCD72C 8L	72"	42"	24"	24"	24"	33"	300	53	\$2,285

Keyboard tray and worksurface black grommet standard. Upgrade grommet cover to silver, N/C.

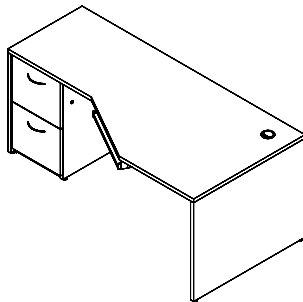

Computer Corner, File/File Pedestal Left (H3B handles, lock, Full modesty)

Model#	(L)	(B)	(E)	(K)	(R)	(W)	Weight	Cube	Price
MCCD60D 2L	60"	30"	20"	21"	20"	21"	235	32	\$1,734
MCCD60D 4L	60"	36"	24"	21"	24"	22"	235	32	\$1,756
MCCD66D 4L	66"	36"	24"	21"	24"	24"	245	42	\$1,786
MCCD72D 3L	72"	36"	20"	24"	20"	33"	265	45	\$1,866
MCCD72D 4L	72"	36"	24"	21"	24"	30"	265	45	\$1,786
MCCD72D 7L	72"	36"	24"	23"	20"	32"	300	45	\$1,907
MCCD72D 8L	72"	42"	24"	24"	24"	33"	300	53	\$2,212

Keyboard tray and worksurface black grommet standard. Upgrade grommet cover to silver, N/C.

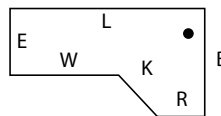

- "L" Length along approach edge
- "B" Back end panel
- "E" End panel
- "K" Keyboard space
- "R" Return size to attach
- "W" Workarea (kbrd to end)

See available accessories and upgrades, pp. 37-38.

maverick complete

CompuCorner Credenzas

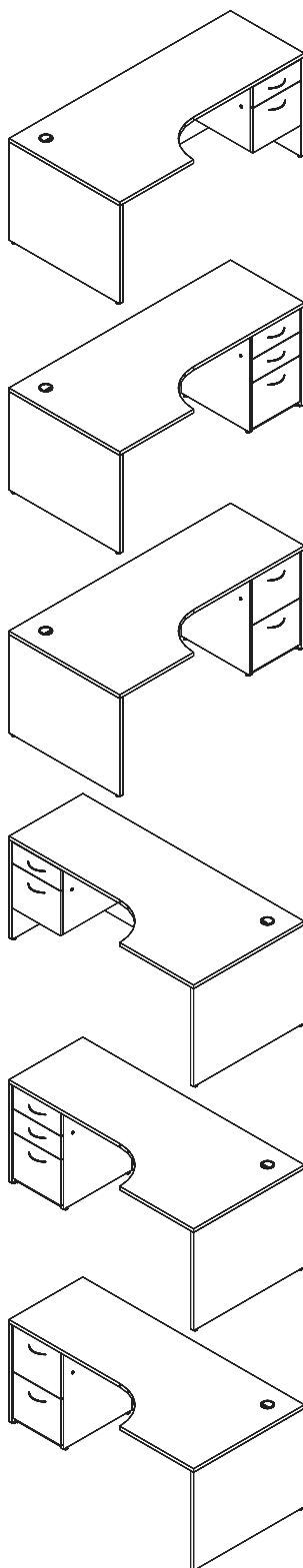

Computer Corner, Curved, 3/4 Box/File Pedestal Right (H3B handles, lock, Full modesty)

Model#	(L)	(B)	(E)	(K)	(R)	(W)	Weight	Cube	Price
☞ MCCDQ72 4R	72"	36"	24"	21"	24"	30"	239	45	\$1,382

No keyboard tray. Worksurface black grommet standard. Upgrade grommet cover to silver, N/C.

Computer Corner, Curved, Box/Box/File Pedestal Right (H3B handles, lock, Full modesty)

Model#	(L)	(B)	(E)	(K)	(R)	(W)	Weight	Cube	Price
☞ MCCDQ72C 4R	72"	36"	24"	21"	24"	30"	254	45	\$1,859

No keyboard tray. Worksurface black grommet standard. Upgrade grommet cover to silver, N/C.

Computer Corner, Curved, File/File Pedestal Right (H3B handles, lock, Full modesty)

Model#	(L)	(B)	(E)	(K)	(R)	(W)	Weight	Cube	Price
☞ MCCDQ72D 4R	72"	36"	24"	21"	24"	30"	254	45	\$1,789

No keyboard tray. Worksurface black grommet standard. Upgrade grommet cover to silver, N/C.

Computer Corner, Curved, 3/4 Box/File Pedestal Left (H3B handles, lock, Full modesty)

Model#	(L)	(B)	(E)	(K)	(R)	(W)	Weight	Cube	Price
☞ MCCDQ72 4L	72"	36"	24"	21"	24"	30"	239	45	\$1,382

No keyboard tray. Worksurface black grommet standard. Upgrade grommet cover to silver, N/C.

Computer Corner, Curved, Box/Box/File Pedestal Left (H3B handles, lock, Full modesty)

Model#	(L)	(B)	(E)	(K)	(R)	(W)	Weight	Cube	Price
☞ MCCDQ72C 4L	72"	36"	24"	21"	24"	30"	254	45	\$1,859

No keyboard tray. Worksurface black grommet standard. Upgrade grommet cover to silver, N/C.

Computer Corner, Curved, File/File Pedestal Left (H3B handles, lock, Full modesty)

Model#	(L)	(B)	(E)	(K)	(R)	(W)	Weight	Cube	Price
☞ MCCDQ72D 4L	72"	36"	24"	21"	24"	30"	254	45	\$1,789

No keyboard tray. Worksurface black grommet standard. Upgrade grommet cover to silver, N/C.

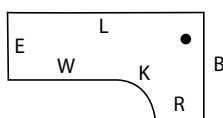

"L" Length along approach edge

"B" Back end panel

"E" End panel

"K" Keyboard space

"R" Return size to attach

"W" Workarea (kbrd to end)

See available accessories and upgrades, pp. 37-38.

maverick complete

CompuCorner Credenzas

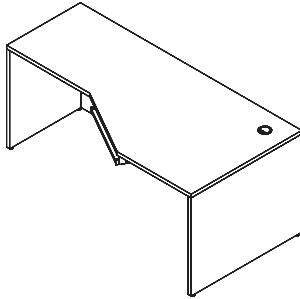

Computer Corner Shell (Full modesty), For Right Return

Model#	(L)	(B)	(E)	(K)	(R)	(W)	Weight	Cube	Price
MCCDN60 2R	60"	30"	20"	21"	20"	21"	184	32	\$981
MCCDN72 3R	72"	36"	20"	24"	20"	33"	213	45	\$1,137
MCCDN72 4R	72"	36"	24"	21"	24"	30"	213	45	\$1,175

Keyboard tray and worksurface black grommet standard. Upgrade grommet cover to silver, N/C.

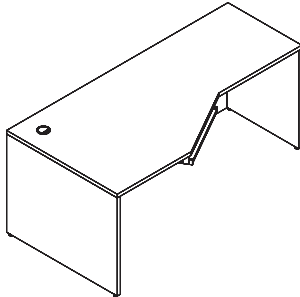

Computer Corner Shell (Full modesty), For Left Return

Model#	(L)	(B)	(E)	(K)	(R)	(W)	Weight	Cube	Price
MCCDN60 2L	60"	30"	20"	21"	20"	21"	184	32	\$981
MCCDN72 3L	72"	36"	20"	24"	20"	33"	213	45	\$1,137
MCCDN72 4L	72"	36"	24"	21"	24"	30"	213	45	\$1,175

Keyboard tray and worksurface black grommet standard. Upgrade grommet cover to silver, N/C.

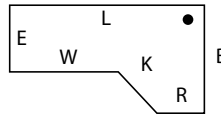

- "L" Length along approach edge
- "B" Back end panel
- "E" End panel
- "K" Keyboard space
- "R" Return size to attach
- "W" Workarea (kbrd to end)

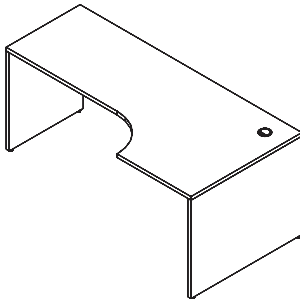

Computer Corner Shell, Curved (Full modesty), For Right Return

Model#	(L)	(B)	(E)	(K)	(R)	(W)	Weight	Cube	Price
MCCDNQ72 4R	72"	36"	24"	21"	24"	30"	213	45	\$1,175

Worksurface black grommet standard. No keyboard tray. Upgrade grommet cover to silver, N/C.

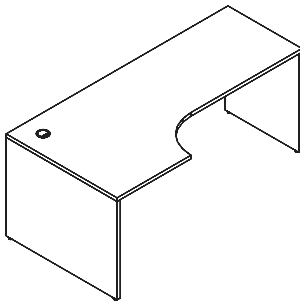

Computer Corner Shell, Curved (Full modesty), For Left Return

Model#	(L)	(B)	(E)	(K)	(R)	(W)	Weight	Cube	Price
MCCDNQ72 4L	72"	36"	24"	21"	24"	30"	213	45	\$1,175

Worksurface black grommet standard. No keyboard tray. Upgrade grommet cover to silver, N/C.

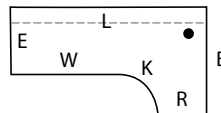

- "L" Length along approach edge
- "B" Back end panel
- "E" End panel
- "K" Keyboard space
- "R" Return size to attach
- "W" Workarea (kbrd to end)

maverick complete

Credenzas

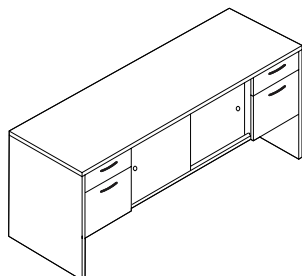

Credenza, Double Pedestal, Box/File Left and Right, Center Storage
(Sliding doors, Full modesty, H3B handles, 2 locks)

Model#	Depth	Width	Height	Weight	Cube	Price
MCC2060 2	20"	60"	29"	230	21	\$1,501
MCC2066 2	20"	66"	29"	240	23	\$1,736
MCC2072 2	20"	72"	29"	250	25	\$1,752
MCC2472 2	24"	72"	29"	270	30	\$1,848

Storage includes one adjustable ¾"-thick shelf.
NOTE: Pedestal locks are inside doors.

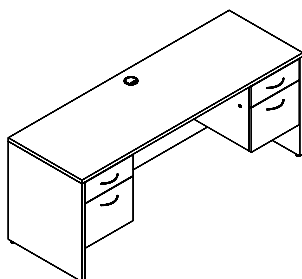

Credenza, Double Pedestal, Box/File Left and Right
(Knee space, Full modesty, H3B handles, 2 locks)

Model#	Depth	Width	Height	Weight	Cube	Price
MCC2060 3	20"	60"	29"	196	21	\$1,521
MCC2066 3	20"	66"	29"	205	23	\$1,762
MCC2072 3	20"	72"	29"	210	25	\$1,790
MCC2472 3	24"	72"	29"	230	30	\$1,830

Black grommet center top and modesty. Upgrade grommet cover to silver, N/C.

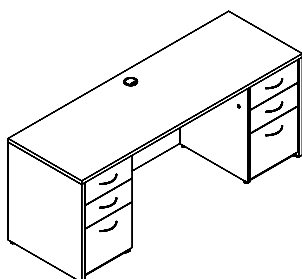

Credenza, Double Pedestal, Box/Box/File Left and Right
(Knee space, full modesty, H3B handles, 2 locks)

Model#	Depth	Width	Height	Weight	Cube	Price
MCCC2060 3	20"	60"	29"	245	21	\$2,137
MCCC2066 3	20"	66"	29"	255	23	\$2,381
MCCC2072 3	20"	72"	29"	265	25	\$2,406
MCCC2472 3	24"	72"	29"	290	30	\$2,447

Black grommet center top and modesty. Upgrade grommet cover to silver, N/C.
For left Box/Box/File and right File/File configuration use MCCCDD____. N/C.

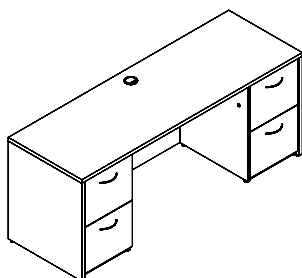

Credenza, Double Pedestal, File/File Left and Right
(Knee space, full modesty, H3B handles, 2 locks)

Model#	Depth	Width	Height	Weight	Cube	Price
MCCD2060 3	20"	60"	29"	245	21	\$2,040
MCCD2066 3	20"	66"	29"	255	23	\$2,286
MCCD2072 3	20"	72"	29"	265	25	\$2,311
MCCD2472 3	24"	72"	29"	290	30	\$2,352

Black grommet center top and modesty. Upgrade grommet cover to silver, N/C.

maverick complete

Hutches

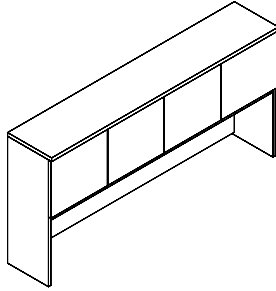

Hutch Four Doors with Fascia (18" below Fascia)

Model#	Depth	Width	Height	# Doors	Weight	Cube	Price
MCH48WD	14"	48"	36"	4	130	14	\$1,333
MCH60WD	14"	60"	36"	4	155	18	\$1,426
MCH66WD	14"	66"	36"	4	167	20	\$1,539
MCH72WD	14"	72"	36"	4	179	21	\$1,574

Optional face locks (2 locks required), add MM FL...\$90 each.
Ends are 3/4" thick; doors overlay legs but are inset to the 1"-thick top.
35lb. weight capacity distributed evenly.

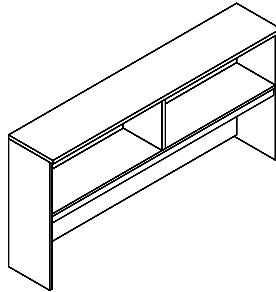

Hutch No Doors with Fascia (18" below Fascia)

Model#	Depth	Width	Height	Weight	Cube	Price
MCH48ND	14"	48"	36"	115	14	\$1,004
MCH60ND	14"	60"	36"	135	18	\$1,037
MCH66ND	14"	66"	36"	148	20	\$1,116
MCH72ND	14"	72"	36"	160	21	\$1,219

Ends are 3/4" thick; doors overlay legs but are inset to the 1"-thick top.
35lb. weight capacity distributed evenly.

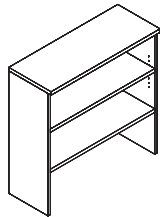

Bookcase Hutch, Full Back Panel

(One adjustable shelf, One fixed shelf, 1"-thick shelves) Bottom Clearance 12"H

Model#	Depth	Width	Height#	Shelves	Weight	Cube	Price
MCBCH	14"	36"	36"	2	72	11	\$520

Ends are 3/4" thick; legs are inset to the 1"-thick top. Width coordinates with lateral files and utility cabinets.
35lb. weight capacity distributed evenly.

NOTE: If hutch is placed on L-unit return 1/2 leg support is required, add MMSPT \$130.

maverick complete

Bookcases

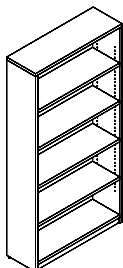

Bookcase (1"-thick adjustable shelves)

Model#	Depth	Width	Height	# Shelves	Weight	Cube	Price
☞ MCBC3630	12"	36"	29"	1	61	18	\$502
☞ MCBC3648	12"	36"	48"	2	86	12	\$676
☞ MCBC3660	12"	36"	60"	3	107	15	\$813
☞ MCBC3665	12"	36"	65"	3	111	17	\$848
☞ MCBC3672	12"	36"	72"	4	128	18	\$881
☞ MCBC3684	12"	36"	84"	5	137	21	\$1,101

For additional adjustable shelf, add MMSH1 \$130 ea. Includes 4-pins per shelf.

Storage

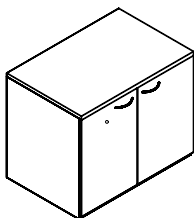

Hinged Door Utility Cabinet (H3B handle, one ¾"-thick adjustable shelf, lock)

Model#	Depth	Width	Height	Weight	Cube	Price
☞ MCHDC2036	20"	36"	29"	115	13	\$1,029
☞ MCHDC2436	24"	36"	29"	175	15	\$1,169

Width coordinates with bookcase hutch.

Files

(All drawers are 16"D except vertical files)

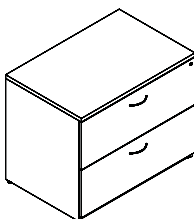

2-Drawer Lateral File (H3B handles, lock) Anti-Tip Interlock

Model#	Depth	Width	Height	Weight	Cube	Price
☞ MCLF202	20"	36"	29"	135	11	\$1,259
☞ MCLF242	24"	36"	29"	147	13	\$1,313

Includes Anti-Tip Interlock.

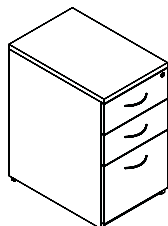

MCVFC

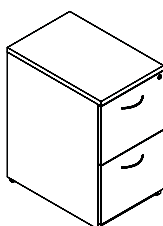

MCVF2

Vertical Files (H3B handles, lock)

Model#	Depth	Width	Height	20"D Drawers	Weight	Cube	Price
☞ MCVF2	24"	16"	29"	2	160	7	\$896
☞ MCVFC	24"	16"	29"	3	160	7	\$983

NOTE: All files recommended capacity is 75%, do not overload.

maverick complete

Upgrade and Accessories

STANDARD HANDLE OPTIONS, FOR MAVERICK COMPLETE N/C.

H3B is standard if none specified.

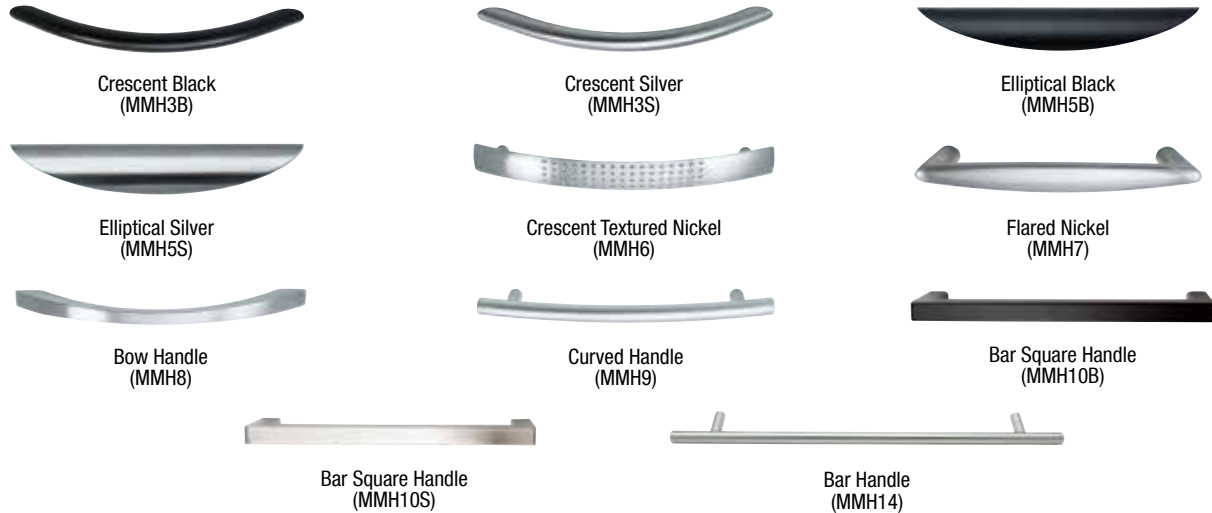

GROMMETS

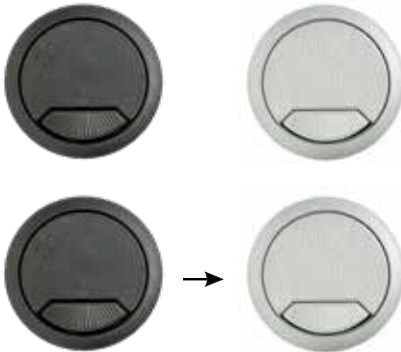

Grommet

Model#	Color	Depth	Width	Surface Hole Diameter	Price
MMGR234B	Black Plastic	3"	3"	2 3/4"	\$56
MMGR234S	Silver Plastic	3"	3"	2 3/4"	\$56

Grommet Color, Upgrade from Standard Black to Silver

Model#	Color	Depth	Width	Surface Hole Diameter	Price
MMUGR234S	Silver Plastic	3"	3"	2 3/4"	No Charge

GROMMETS LOCATION (Worksurface and modesty)

NOTE: While sitting at unit, grommet locations named from left to right.
For grommet location on tops and/or modesty panel specify left, center or right.
No grommets over pedestals.

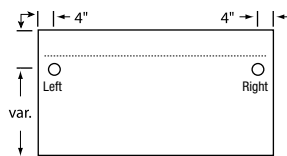

Desks

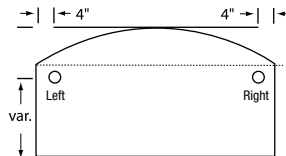

Desks

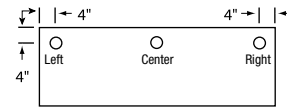

Credenza, Return, Bridges

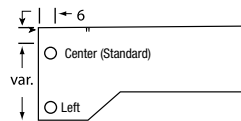

CompuCredenza

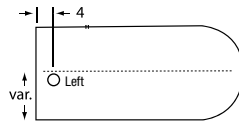

Bullets

Note: Black grommets are standard where shown on line drawings.

maverick complete

Accessories and Upgrades

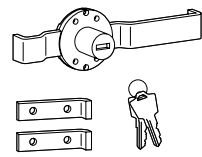

Pedestal Lock (Mounted on side of pedestal)		
Model#	Description	Price
MMPL	Side pedestal lock	\$90

For freestanding pedestals, specify left or right side pedestal lock installation. Lock numbers (#101-115) are randomly assigned, key alike must be specify. No charge.

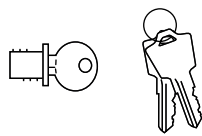

Face Lock		
Model#	Description	Price
MMFL	Face lock for TFM doors or center drawers	\$90

MMFL: 1 per set of 2 doors. Hutch with 4 doors requires 2 locks. Lock numbers (#101-115) are randomly assigned, key alike must be specify. No charge.

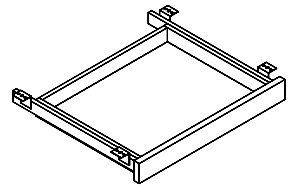

Center Drawer (9-ply birch wood drawer interior, specify front laminate color)						
Model#	Depth	Width	Height	Weight	Cube	Price
MMCD	16"	21"	2 1/2"	12	.5	\$170



Box Drawer Convenience Tray, Black (Insets to box drawer)						
Model#	Depth	Width	Height	Weight	Cube	Price
MMBPT	5 1/2"	12"	1"	1	.5	\$32

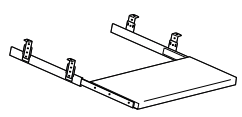

Keyboard Tray, Rollout (Specify laminate color)						
Model#	Depth	Width	Height	Weight	Cube	Price
MMKB	16"	21"	3"	10	.5	\$156

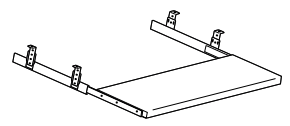

Oversize Keyboard Tray, Rollout (Specify laminate color)						
Model#	Depth	Width	Height	Weight	Cube	Price
MMKBLG	16"	28"	3"	12	.5	\$230

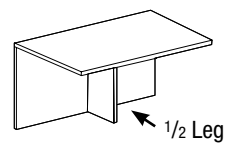

Half-Leg Support with Leveler (finished 3-sides)						
Model#	Depth	Width	Height	Weight	Cube	Price
MMSPT	12"	1"	28"	11	3	\$130

Support leg can also be used to create freestanding returns. Specify freestanding and left or right 1/2" leg. Support leg is required if placing hutch on L-unit return. Add to long pieces for support.

conference collection and training tables

Maverick Series

1¾"-high built-up edge of thermally-fused melamine laminate with 2mm-thick PVC edge band.
Radius corners. Round tables are 1" thick.

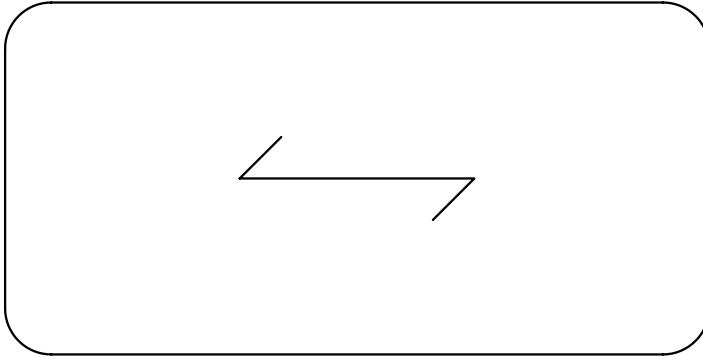

Edge Detail

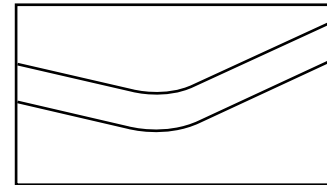

Arroyo Series

1"-thick top of thermally-fused melamine laminate with 2mm-thick PVC edge band.
Square corners.

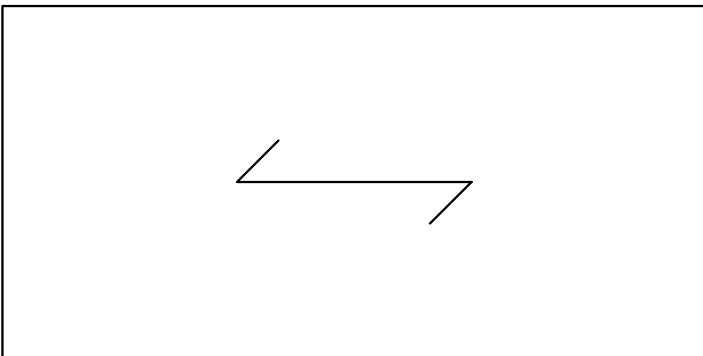

Edge Detail

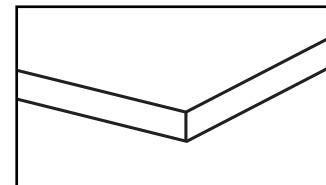

conference collection

Maverick Series - Conference Table Tops

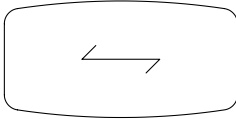

Boatshape Conference Table Top (1 3/4" thick build up edge, radius corners)

Model#	Depth	Width	Height	Top	Weight	Cube	Price
☞ MMBS3672	30" / 36"	72"	1 3/4"	1 pc	122	3	\$689
☞ MMBS4284	36" / 42"	84"	1 3/4"	1 pc	156	4	\$791
☞ MMBS4296	36" / 42"	96"	1 3/4"	1 pc	176	4	\$890

Tops require 2 bases.

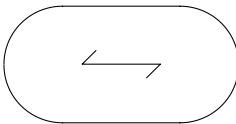

Racetrack Conference Table Top (1 3/4" thick build up edge)

Model#	Depth	Width	Height	Top	Weight	Cube	Price
☞ MMRT3672	36"	72"	1 3/4"	1 pc	122	3	\$806
☞ MMRT4284	42"	84"	1 3/4"	1 pc	156	4	\$939
☞ MMRT4296	42"	96"	1 3/4"	1 pc	176	4	\$1,042

Tops require 2 bases.

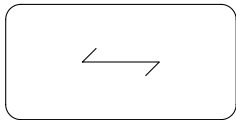

Rectangular Conference Table Top (1 3/4" thick build up edge, radius corners)

Model#	Depth	Width	Height	Top	Weight	Cube	Price
☞ MMRE3672	36"	72"	1 3/4"	1 pc	122	3	\$654
☞ MMRE4284	42"	84"	1 3/4"	1 pc	156	4	\$689
☞ MMRE4296	42"	96"	1 3/4"	1 pc	176	4	\$822

Tops require 2 bases.

Round Table Tops

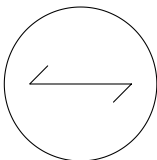

Round Table Table Top (1" thick)

Model#	Depth	Width	Height	Bases(Required)	Weight	Cube	Price
☞ MMRD36	36"	36"	1"	1	36	6	\$472
☞ MMRD42	42"	42"	1"	1	49	7	\$572
☞ MMRD48	48"	48"	1"	1	64	8	\$722

REMINDER: Prices are for TOPS ONLY - Order legs/bases separately.

conference collection

Arroyo Series - Conference Table Tops

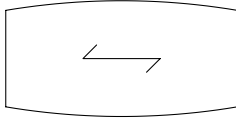

Boatshape Conference Table Top (1" thick top, square corners)

Model#	Depth	Width	Height	Top	Weight	Cube	Price
ARBS3672	30" / 36"	72"	1"	1 pc	72	2	\$553
ARBS4284	36" / 42"	84"	1"	1 pc	97	2	\$654
ARBS4296	36" / 42"	96"	1"	1 pc	111	3	\$737

Tops require 2 bases.

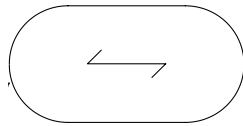

Racetrack Conference Table Top (1" thick top)

Model#	Depth	Width	Height	Top	Weight	Cube	Price
ARRT3672	36"	72"	1"	1 pc	72	2	\$572
ARRT4284	42"	84"	1"	1 pc	97	2	\$671
ARRT4296	42"	96"	1"	1 pc	111	3	\$757

Tops require 2 bases.

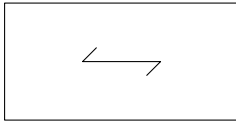

Rectangular Conference Table Top (1" thick top, square corners)

Model#	Depth	Width	Height	Top	Weight	Cube	Price
ARRE3672	36"	72"	1"	1 pc	72	2	\$487
ARRE4284	42"	84"	1"	1 pc	97	2	\$588
ARRE4296	42"	96"	1"	1 pc	111	3	\$672

Tops require 2 bases.

Square Table Tops

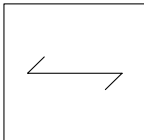

Square Table Table Top (1" thick, square corners)

Model#	Depth	Width	Height	Bases(Required)	Weight	Cube	Price
ARSQ36	36"	36"	1"	1	36	1	\$472
ARSQ42	42"	42"	1"	1	49	1	\$572
ARSQ48	48"	48"	1"	1	64	2	\$722
ARSQ54	54"	54"	1"	1	80	2	\$822

conference collection

Bases for Conference Table Tops

NOTE: Stretcher bars are std., when conference table top and sq. panel legs, are purchased together.



Square Panel Leg, 1" Thick

Model#	Depth	Width	Height	Top Depth	Weight	Cube	Price
☞ ARLEGA20	1"	20"	28"	36"	27	1	\$77/ea.
☞ ARLEGA24	1"	24"	28"	42" & 48"	33	1	\$77/ea.

Use for Arroyo Conference Table Tops only. (AR legs do not support MM Conference Table Tops)
Stretcher bars 1"x7"H are standard (MM stretcher). Must order top and bases together.



Square Panel Leg, 1 3/4" Thick

Model#	Depth	Width	Height	Top Depth	Weight	Cube	Price
☞ MMLEGA20	1 3/4"	20"	28"	36"	27	1	\$169/ea.
☞ MMLEGA24	1 3/4"	24"	28"	42" & 48"	33	1	\$169/ea.

Stretcher bars 1"x7"H are standard (MM stretcher). Must order top and bases together.

Bases, for Round and Square Table Tops

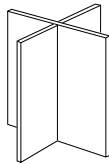

Flat Panel X-Base

Model#	Depth	Width	Height	Top Depth	Weight	Cube	Price
☞ MMLEGF20	20"	20"	28"	36"	31	7	\$269
☞ MMLEGF24	24"	24"	28"	42" & 48"	37	10	\$302



Sculptured Panel X-Base

Model#	Depth	Width	Height	Top Depth	Weight	Cube	Price
☞ MMLEGG20	20"	20"	28"	36"	31	7	\$347
☞ MMLEGG24	24"	24"	28"	42" & 48"	37	10	\$381

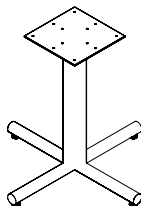

Four-Star Metal Base

Model#	Depth	Width	Height	Top Depth	Weight	Cube	Price
☞ MMLEGI30B	30"	30"	28"	36"	19	17	\$540
☞ MMLEGI36B	36"	36"	28"	42",48"&54"	30	24	\$587
☞ MMLEGI30S	30"	30"	28"	36"	19	17	\$540
☞ MMLEGI36S	36"	36"	28"	42",48"&54"	30	24	\$587

Color choice: MMLEGI_ _B (Black) and MMLEGI_ _S (Silver Powdercoat)

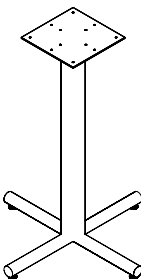

Bar Height Metal Four Star Base

Model#	Depth	Width	Height	Top Depth	Weight	Cube	Price
☞ MMLEGIBH30B	30"	30"	41"	36"	24	25	\$641
☞ MMLEGIBH36B	36"	36"	41"	42",48"&54"	35	35	\$688
☞ MMLEGIBH30S	30"	30"	41"	36"	24	25	\$641
☞ MMLEGIBH36S	36"	36"	41"	42",48"&54"	35	35	\$688

Color choice: MMLEGIBH_ _B (Black) and MMLEGIBH_ _S (Silver Powdercoat)

conference collection

Bases, for Round and Square Table Tops

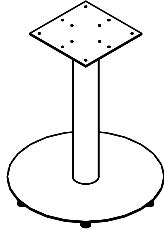

Round Disc Metal Base

Model#	Depth	Width	Height	Top Depth	Weight	Cube	Price
☞ MMLEGR24B	24"	4"	27¾"	36", 42" & 48"	45	10	\$1,080
☞ MMLEGR28B	28"	4"	27¾"	54"	50	13	\$1,238
☞ MMLEGR24S	24"	4"	27¾"	36", 42" & 48"	45	10	\$1,080
☞ MMLEGR28S	28"	4"	27¾"	54"	50	13	\$1,238

Color Choice: MMLEGR_ _B (Black) or MMLEGR_ _S (Silver).
Leg Notes: Fixed mounting plate 12" x 12"

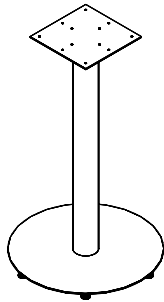

Round Disc Metal Base, Bar Height

Model#	Depth	Width	Height	Top Depth	Weight	Cube	Price
☞ MMLEGRBH24B	24"	4"	40 ¾"	36" & 42"	50	14	\$1,178
☞ MMLEGRBH28B	28"	4"	40 ¾"	48"D	55	19	\$1,354
☞ MMLEGRBH24S	24"	4"	40 ¾"	36" & 42"	50	14	\$1,178
☞ MMLEGRBH28S	28"	4"	40 ¾"	48"D	55	19	\$1,354

Color Choice: MMLEGRBH_ _B (Black) or MMLEGRBH_ _S (Silver).
Leg Notes: Fixed mounting plate 12" x 12"

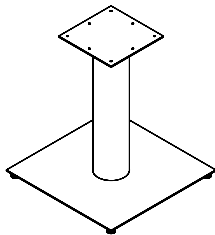

Square Metal Base

Model#	Depth	Width	Height	Top Depth	Weight	Cube	Price
☞ MMLEGS20B	20"	4"	27 ¾"	36"	45	10	\$1,080
☞ MMLEGS20S	20"	4"	27 ¾"	36"	45	10	\$1,080
☞ MMLEGS30B	30"	6"	27 ¾"	42" & 48"	50	13	\$1,238
☞ MMLEGS30S	30"	6"	27 ¾"	42" & 48"	50	13	\$1,238

Color Choice: MMLEGS_ _B (Black) or MMLEGS_ _S (Silver).
Leg Notes: Fixed mounting plate 12" x 12"

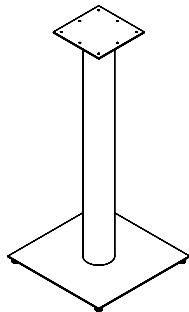

Square Metal Base, Bar Height

Model#	Depth	Width	Height	Top Depth	Weight	Cube	Price
☞ MMLEGSBH20B	20"	4"	40 ¾"	36"	50	14	\$1,178
☞ MMLEGSBH20S	20"	4"	40 ¾"	36"	50	14	\$1,178
☞ MMLEGSBH30B	30"	6"	40 ¾"	42" & 48"	55	14	\$1,354
☞ MMLEGSBH30S	30"	6"	40 ¾"	42" & 48"	55	14	\$1,354

Color Choice: MMLEGSBH_ _B (Black) or MMLEGSBH_ _S (Silver).
Leg Notes: Fixed mounting plate 12" x 12"

training tables

Training Worksurfaces

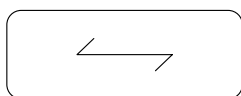
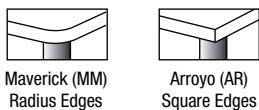

Maverick

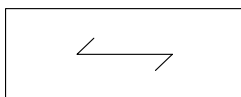

Arroyo

Rectangular Training Table Top, 20"D Tops (MM-radius edges, AR-square edges)							
Model#	Depth	Width	Height	Weight	Cube	MM Price	AR Price
__TR2036	20"	36"	1"	23	1	\$222	\$198
__TR2042	20"	42"	1"	27	1	\$227	\$204
__TR2048	20"	48"	1"	30	1	\$239	\$216
__TR2054	20"	54"	1"	34	1	\$252	\$228
__TR2060	20"	60"	1"	38	1	\$289	\$259
__TR2066	20"	66"	1"	42	1	\$306	\$276
__TR2072*	20"	72"	1"	45	1	\$330	\$300
__TR2078*	20"	78"	1"	49	1	\$379	\$342
__TR2084*	20"	84"	1"	53	1	\$414	\$372

Note: When ordering, insert MM for Maverick Series or AR for Arroyo Series. Wood grain runs the width direction.
***Tops:** 72"W, 78"W & 84"W require 5-Post Legs.
Stabilizer Bar: 2 are included with 60"W, 66"W & 72"W tops, when ordered with post legs.
 Max weight 50 lbs.
Pre Drill Holes: Tops are pre-drill for 4-Post Legs MMLEGTRB – MMLEGTRSC.
Ganging Hardware: Is recommended when placing tops side by side. Lead Time.

Rectangular Training Table Top, 24"D Tops (MM-radius edges, AR-square edges)							
Model#	Depth	Width	Height	Weight	Cube	MM Price	AR Price
__TR2436	24"	36"	1"	30	1	\$300	\$270
__TR2442	24"	42"	1"	32	1	\$311	\$281
__TR2448	24"	48"	1"	36	1	\$324	\$295
__TR2454	24"	54"	1"	40	1	\$336	\$306
__TR2460	24"	60"	1"	45	1	\$347	\$311
__TR2466	24"	66"	1"	50	1	\$366	\$330
__TR2472*	24"	72"	1"	54	1	\$379	\$342
__TR2478*	24"	78"	1"	59	1	\$414	\$372
__TR2484*	24"	84"	1"	63	1	\$438	\$395

Note: When ordering, insert MM for Maverick Series or AR for Arroyo Series. Wood grain runs the width direction.
***Tops:** 72"W, 78"W & 84"W require 5-Post Legs.
Stabilizer Bar: 2 are included with 60"W, 66"W & 72"W tops, when ordered with post legs.
 Max weight 50 lbs.
Pre Drill Holes: Tops are pre-drill for 4-Post Legs MMLEGTRB – MMLEGTRSC.
Ganging Hardware: Is recommended when placing tops side by side. Lead Time.

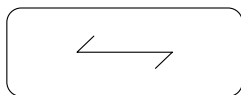

Maverick

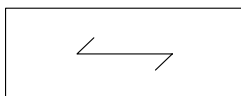

Arroyo

Rectangular Training Table Top, 30"D Tops (MM-radius edges, AR-square edges)							
Model#	Depth	Width	Height	Weight	Cube	MM Price	AR Price
__TR3048	30"	48"	1"	45	1	\$311	\$281
__TR3054	30"	54"	1"	51	1	\$318	\$289
__TR3060	30"	60"	1"	57	1	\$348	\$311
__TR3066	30"	66"	1"	62	1	\$384	\$348
__TR3072*	30"	72"	1"	68	2	\$419	\$379
__TR3078*	30"	78"	1"	74	2	\$478	\$431
__TR3084*	30"	84"	1"	79	2	\$529	\$479

Note: When ordering, insert MM for Maverick Series or AR for Arroyo Series. Wood grain runs the width direction.
***Tops:** 72"W, 78"W & 84"W require 5-Post Legs.
Stabilizer Bar: 2 are included with 60"W, 66"W & 72"W tops, when ordered with post legs.
 Max weight 50 lbs.
Pre Drill Holes: Tops are pre-drill for 4-Post Legs MMLEGTRB – MMLEGTRSC.
Ganging Hardware: Is recommended when placing tops side by side. Lead Time.

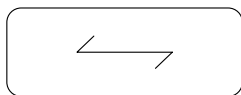

Maverick

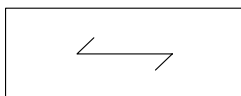

Arroyo

training tables

Training Worksurfaces

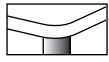

Maverick (MM)
Radius Edges

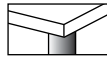

Arroyo (AR)
Square Edges

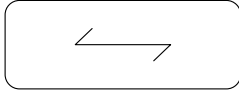

Maverick

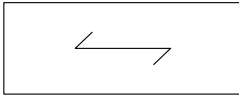

Arroyo

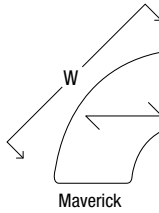

Maverick

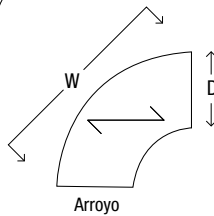

Arroyo

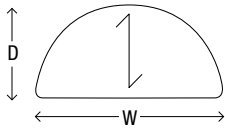

Maverick

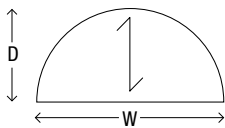

Arroyo



WG24 & WG30

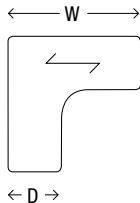

Maverick

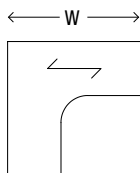

Arroyo

Rectangular Training Table Top, 36" D Tops (MM-radius edges, AR-square edges)

Model#	Depth	Width	Height	Weight	Cube	MM Price	AR Price
__TR3660	36"	60"	1"	68	1	\$461	\$419
__TR3666	36"	66"	1"	75	1	\$498	\$450
__TR3672*	36"	72"	1"	81	2	\$522	\$474

Note: When ordering, insert MM for Maverick Series or AR for Arroyo Series. Wood grain runs the width direction.
Top: 72"W requires 5-post legs.

Stabilizer Bar: 2 are included with 60"W, 66"W & 72"W tops, when ordered with post legs.
Max weight 50 lbs.

Pre Drill Holes: Tops are pre-drill for 4-Post Legs MMLEGTRB – MMLEGTRSC.

Ganging Hardware: Is recommended when placing tops side by side.  Lead Time.

Curved Training Table Top (Must be ganged with another top for stability)

Model#	Depth	Width	Height	Weight	Cube	MM Price	AR Price
__TRQ2460L	24"	60"	1"	27	1	\$355	\$319
__TRQ2460R	24"	60"	1"	27	1	\$355	\$319
__TRQ3060L	30"	60"	1"	33	2	\$392	\$355
__TRQ3060R	30"	60"	1"	33	2	\$392	\$355

Note: When ordering, insert MM for Maverick Series or AR for Arroyo before model number.

On "L" units, from users' view, woodgrain direction is parallel with right edge and perpendicular with left edge.

On "R" units wood-grain is parallel with the left edge and perpendicular with the right edge.

If not ganged, order 5th leg for stability.

Pre Drill Holes: Tops are pre-drill for Post Legs MMLEGTRB – MMLEGTRSC.

Ganging Hardware: Is recommended when placing tops side by side.  Lead Time.

Half-Round Training Table Top (48" & 60" require four legs and two ganging plates)

Model#	Depth	Width	Height	Weight	Cube	MM Price	AR Price
__TRWH1224	12"	24"	1"	6	1	\$177	\$141
__TRWH1224WG24	12"	24"	1"	6	1	\$177	\$141
__TRWH1530	15"	30"	1"	10	1	\$215	\$178
__TRWH1530WG30	15"	30"	1"	10	1	\$215	\$178
__TRWH2448	24"	48"	1"	24	1	\$447	\$410
__TRWH3060	30"	60"	1"	37	1	\$534	\$410

Note: When ordering, insert MM for Maverick Series or AR for Arroyo before model number.

Woodgrain direction runs the depth to coordinate with woodgrain direction on rectangular worksurfaces.

12" & 15" deep require only 1 leg and 1 ganging plate.

12" & 15" deep (WG24 & WG30), the woodgrain runs the width to coordinate with the grain on 1 end of curved units.

Pre Drill Holes: Tops are pre-drill for Post Legs MMLEGTRB – MMLEGTRSC.

Ganging Hardware: Is recommended when placing tops side by side.  Lead Time.

Curved Corner Training Table Top (48" & 60" require four legs and two ganging plates)

Model#	Depth	Width	Height	Weight	Cube	MM Price	AR Price
__TRCWS424224	24"	42" / 42"	1"	24	1	\$460	\$410
__TRCWS424230	30"	42" / 42"	1"	24	1	\$460	\$410
__TRCWS484824	24"	48" / 48"	1"	30	1	\$535	\$476
__TRCWS484830	30"	48" / 48"	1"	30	1	\$535	\$535
__TRCWS606024	24"	60" / 60"	1"	47	1	\$669	\$601
__TRCWS606030	30"	60" / 60"	1"	47	1	\$669	\$601

Note: When ordering, insert MM for Maverick Series or AR for Arroyo before model number.

Pre Drill Holes: Tops are pre-drill for Post Legs MMLEGTRB – MMLEGTRSC.

Ganging Hardware: Is recommended when placing tops side by side.  Lead Time.

training tables

Bases, for Training Table Tops (Leg heights vary and cannot be combined)



Post Leg 2 3/8" diameter (Set of 4 legs) for Training Table Tops

Model#	Description	Color	Height	Price
☞ MMLEGTRB	4 Posts with Leveler	Black	27 13/16"	\$414
☞ MMLEGTRS	4 Posts with Leveler	Brushed Steel	27 13/16"	\$414
☞ MMLEGTRBC	4 Posts with Locking Casters	Black	27 15/16"	\$414
☞ MMLEGTRSC	4 Posts with Locking Casters	Brushed Steel	27 15/16"	\$414
☞ MMCULEG_ _	1 Individual Post Leg		27 15/16"	\$104

For individual post legs...\$104 each. Specify complete model #MMCULEG_ _ (e.g. MMCULEGTRB)
 Individual post leg includes mounting screws.
 Legs are shipped un-installed and require minor assembly with woodscrews for each leg.
 Tops 72"W, 78"W & 84"W requires 5-post legs. Tops are pre-drilled for 4-post legs only.

☞ LEAD TIME



Flip Top Base with Modesty, Locking Casters (Complete leg, black color only)

Model#	Depth	Width	Height	Fits Top Size	Color	Weight	Cube	Price
☞ MMLEGFB4836	20"	24"	28 1/2"	36" & 48"W	Black	42	1	\$468
☞ MMLEGFB7260	20"	58"	28 1/2"	60" & 72"W	Black	42	1	\$635

For rectangular tops 20"D & 24"D only. See p. 44.
 Bases ship unassembled unless otherwise specified. Tops are pre-drilled for flip top bases.
 Ganging hardware is recommended when placing tops side by side. See p. 47.

☞ LEAD TIME

training tables

Accessories and Upgrades

MMGANG3

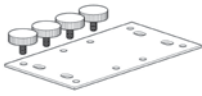

MMGANG4

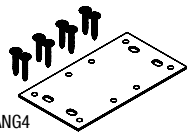

Ganging and Connecting Hardware (For use with factory-installed metal inserts)

Model#	Depth	Width	Height	Hardware	Weight	Cube	Price
MMGANG3	4"	6"	.25"	Ganging	1	1	\$43
MMGANG4	4"	6"	.25"	Connecting	1	1	\$43

MMGANG3: (1) Bracket & (4) Knobs. Recommended when placing tops side by side.
MMGANG4: (1) Bracket & (4) Screws. Can be used for "L" shape & "U" shape connections.



Grommet

Model#	Depth	Width	Color	Surface Hole Diameter	Price
MMGR234B	3"	3"	Black Plastic	2 3/4"	\$56
MMGR234S	3"	3"	Silver Plastic	2 3/4"	\$56

Specify grommet locations. Standard left, right or center, see p. 157 for standard location.

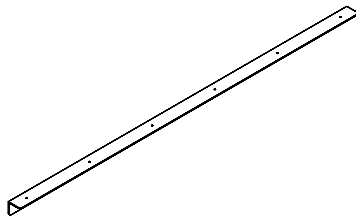

Stabilizer Bar, Black

Model#	Depth	Width	Height	Fits Top	Price
MMSB60	1"	44"	1"	60"W	\$85
MMSB66	1"	50"	1"	66"W	\$92
MMSB72	1"	56"	1"	72"W	\$99

May be purchased separately.
 2 Stabilizer bars are included with 60"W, 66"W & 72"W tops, when purchased with top and post legs.

TRAINING TABLE TOP STANDARD GROMMET LOCATIONS (Unless otherwise specified)

Note: While sitting at unit, grommet locations are named from left to right. Line drawings shown below are standard locations.

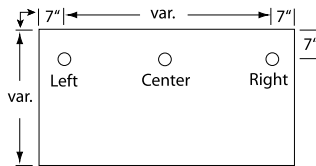

Rectangular
24" or 30"

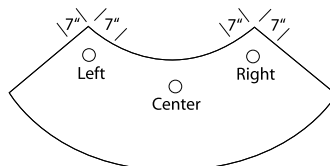

Curved
24" or 30"

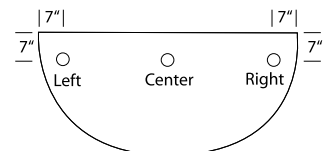

Half-Round
48" or 60"

maverick collection color options

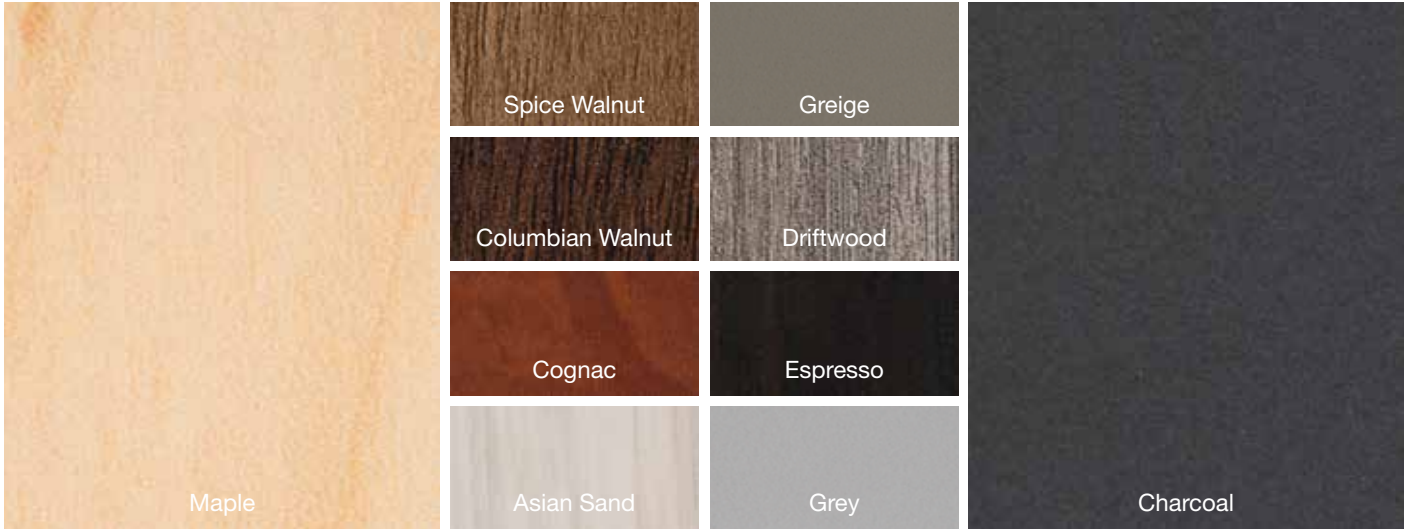

finishes

get creative with our desk designer
maverickdeskdesigner.com



The Fastest

DESK

ESTABLISHED 1992

IN THE WEST

MAVERICKDESK.COM

MAVERICK
OFFICE SOLUTIONS | MADE IN THE U.S.A